

EGAN

2021

Price & Specification Guide

Canadian PSG



Version 10



Instant Ship



The Egan Instant Ship list is a collection of Egan's most popular products and sizes that can be shipped within 2 business days of receiving an order*.

PRESENTATION BOARDS

The Aluminum Frame Markerboard is a classic. Our proprietary dry-erase surface, EVS, is a commercial grade surface that can withstand the toughest environments and is guaranteed-to-clean. With a magnetic backer infill, the Aluminum Frame markerboard is magnet compatible with a clear anodized aluminum frame, precision squared mitered corners and will never warp.

Dimension Stele is an elevated design on the traditional markerboard. Fully wrapped in EVS, Dimension Stele is a 1" frameless board that beautifully blends into your environment; designed specifically for free flow thinking, with clean lines to keep the mind clear and free from distraction.

GlassWriteMAG is a backpainted white, frameless glass board. Egan uses high quality, tempered safety glass that has no tint and will not distort the color of your board. Cleat mounted and magnet compatible.

V-Series Mobile features EVS dry-erase surface on both sides that accepts magnetic accessories. The V-Series frame is defined by robust, clear anodized aluminum.

	V-Series Mobile	Dimension Stele	GlassWrite MAG	Aluminum Frame Markerboard
48"w x 48"h	-	\$1 415	\$2 210	\$ 690
60"w x 48"h	-	\$1 540	\$2 430	\$810
72"w x 48"h	-	\$1 620	\$2 840	\$930
96"w x 48"h	-	\$1 840	\$3 460	\$1 090
48"w x 72"h	\$1 890	-	-	-

Code	Product	Surface	Frame/Edge	Mount
DM	Dimension Stele	EVS	White	Wall
DGM	GlassWrite MAG	White	Frameless	Wall
MES	Aluminum Frame Markerboard	EVS	Clear Anodized	Wall
VSF	V-Series Mobile	EVS both sides	Clear Anodized	Mobile

ACCESSORIES

EganONE Tray, a sleek, aluminum marker tray that comes in a 2" deep design to accommodate 2 rows of markers, and provides an attachment point for the new Egan Cloth.

Code	Dimensions	Price
ACEOT12M (Magnetic Mount)	12"w x 1-3/8"h x 2"d	\$160
ACEOT12A (Adhesive Mount)	24"w x 1-3/8"h x 2"d	\$180

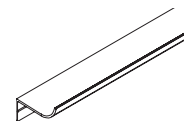

HOW TO ORDER

DM 60 48

Product Code Width Height

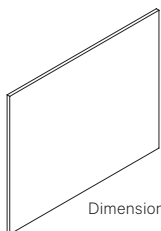

DGM 48 48

Product Code Width Height

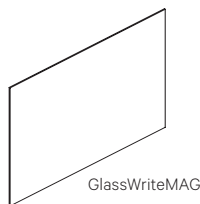

MES 96 48

Product Code Width Height

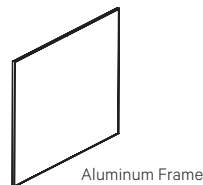

VSF 48 72

Product Code Width Height

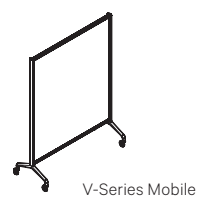

*Orders exceeding six (6) units per product are subject to longer lead times



Egan Versa Presentation Surface (EVS™) is an Egan exclusive patented-technology presentation surface introduced in 2002. It is a unique invention that distinguishes Egan products from the rest in the presentation furniture industry. EVS has inspired the creation of various whiteboard and projection screen product offerings. It is the unique tool for generating, capturing and presenting ideas. This technology surface enhances communication by supporting whiteboard brainstorming as well as data projection of popular presentation formats.

The matte-white finish reduces glare from ambient light in office environments. Glare can cause a reduction in character-to-background contrast, reducing the legibility of screen characters, which at the extreme can cause the contents of the whiteboard to become unrecognizable. Because this only affects viewing at eye level and from only parts of the room, many whiteboard users are not even aware of this major shortcoming! To overcome glare, whiteboard readers will often squint or move about to minimize the effect. EVS solves that problem.

EVS provides a matte-white surface with an incredibly low-gloss factor that is guaranteed-to-clean. The unique surface provides a comfortable 160° viewing angle of your projected image. That means you get a crisp, clear view from almost any angle in the room, without dimming the lights.

When mounted on steel, EVS accepts magnetic accessories.

Versatility is also found in EVS' configurability. EVS is available in a variety of large and small format applications, can be applied on almost any even surface, and can be specified in a variety of sizes and shapes. Apply EganINK™ graphics, and let the sky be your limit! EVS is guaranteed-to-clean for 10 years.



White Porcelain Porcelain Dry-Erase Vinyl EVS

Above images illustrate the difference in surface glare on leading whiteboards

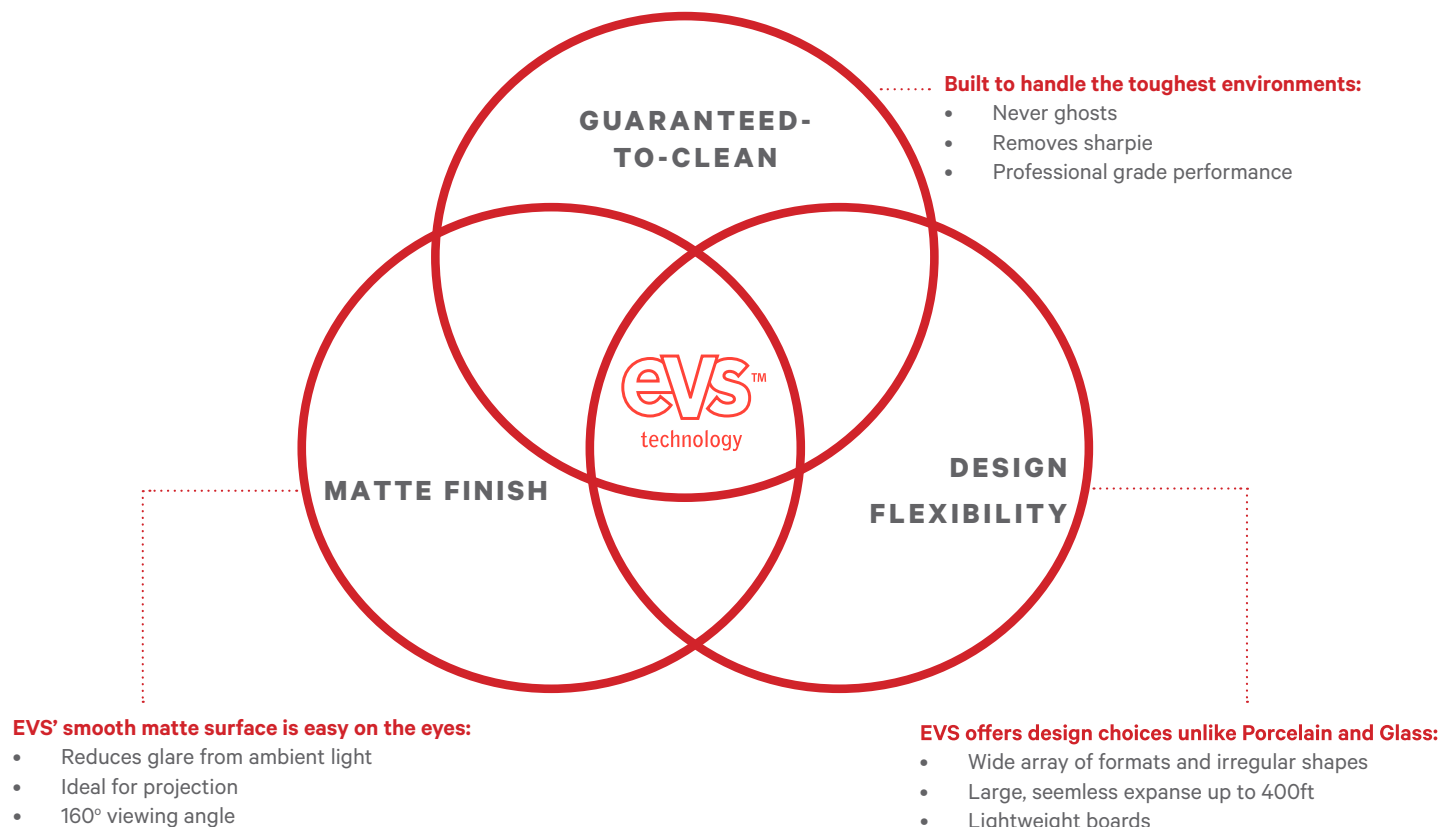

Need Info Now?



Speak with a live Customer Service Rep

1-800-263-2387

+1-905-851-2826

Live coverage Mon-Fri 8:00-6:00 EST



Speak with your local Egan Manufacturer's Rep

Egan Visual has a network of professional sales representatives covering every major market in the US and Canada.

Visit <https://egan.com/rep-locator/> or contact Egan Customer Service and we will be happy to connect you directly.



Email a Customer Service Rep or Sales Team Member

customerservice@egan.com

sales@egan.com



Receive Egan Updates

Subscribe to Egan News & Product Bulletins: email "Subscribe" to marketing@egan.com



Egan Website

www.egan.com.

Retrieve complete and up-to-date information online:

- Latest Specifications
- New Features
- What's New
- Resources: Installation Guides, LEED Data Sheets, GREENGUARD® Certificates, Videos

Connect with Egan



Browse galleries, images and virtual showrooms

www.pinterest.com/eganvisual



Be a friend of Egan on Facebook

www.facebook.com/egan.visual



Watch videos on YouTube

www.youtube.com/eganvisual



Follow Egan on Instagram

[@eganvisualinc](https://www.instagram.com/eganvisualinc)



Connect with Egan on LinkedIn

www.linkedin.com/company/egan-visual

Additional Online Industry Presence

myresourcelibrary.com



2020spaces.com



projectmatrix.com



gsaadvantage.gov



Contracts and Buying Groups



Government Contracts

Egan is participating as a vendor on many government procurement contracts and market-specific buying groups (such as Healthcare, or Education). Below are some of the contracts Egan is an official vendor for. For most up to date list, please visit www.egan.com.



GSA
CMAS
MHEC

State of Alabama
State of Georgia
State of Pennsylvania
State of Mississippi
State of Connecticut



For most up to date list of State Contracts and Buying Groups and contract details visit www.egan.com.

TABLE OF CONTENTS

PRESENTATION BOARDS

Dimension: Overview	7
Dimension Stele 13	8
Dimension Stele	8
Dimension Stele Plus	8
Dimension Stele Integral	8
Dimension Stratus	8
Dimension Tack	8
Dimension Stele LINXX	9

Architrave : Overview	10
Architrave Markerboard: EVS, Glass, Tack	11

Boxcore: Overview	12
Boxcore 19: EVS, Glass, Tack	13
Boxcore 29: EVS, Glass, Tack	14
Standing Rigging	15

Classic: Overview	16
Aluminum Frame Markerboard & Tackboard	17
Linked Aluminum Frame Markerboard & Tackboard	18
Aluminum Frame Full Length Marker Tray	19
Hardwood Frame Markerboard & Tackboard	20
Linked Hardwood Frame Markerboard & Tackboard	21

GLASS MARKERBOARDS

EganAero: Overview	22
EganAero Hover	23
EganAero Boxcore	23
EganAero Architrave	23

GlassWrite: Overview	24
GlassWrite Clear & Frosted	25-26
GlassWrite Shapes	25-26
GlassWrite Colors	25-26
GlassWriteMAG	25-26
GlassWriteMAG Boxcore	25-26
GlassWriteMAG Architrave	25-26
GlassWrite LINXX	26
GlassWrite Envoy	27

EGAN WALL SYSTEM

Wall System: Overview	28
VersaPRO® Wallcovering	29
Framing/ Tracks Options	30-32
Egan System Markerboards & Tackboards	33
Lightweight: VersaBoard	34-35
Egan System Shelving	36
Egan System Cabinets	37
VersaJOT	38
VersaMAG	39

CABINETS

Cabinets: Overview	40
Classic	
Egan Etex Cabinet	41
Egan Wood Cabinet	42-43
Dimension - VersaCabinet	44
Boxcore Cabinets	
EVS, GlassWrite, EganAero	45

MOBILES

Mobiles: Overview	46
--------------------------	----

Architrave Mobile: EVS & Tack	47
Architrave Mobile: Glass	48
Boxcore Mobile: EVS & Tack	49
Boxcore Mobile: Glass	50

V-Series Mobile	
V-Series Mobile - Single Panel & Split Panel	51-52
V-Series Mobile - GlassWrite	53
Classic Egan Lite Mobile & Screen Door	54
Wall System A-Frame VersaMobile	55

TABLESCREENS/ DESK DIVIDERS

TableScreens Overview	56
Mount Options	57
Architrave TableScreen: EVS & Tack	58
Architrave TableScreen: Glass	59
Boxcore 29 TableScreen: EVS & Tack	60
Boxcore 29 TableScreen: Glass	61
GlassWrite TableScreens	62
Dimension TableScreens	63
V-Series TableScreens: EVS, Glass, Tack	64
Fabric TableScreens	65

SOUND IDEAS

Sound Ideas: Overview	66
Egan Disperse	
Mobile	67
Wall Mount	67
Wall Panels	
Acoustical Panel System - Series 3	68-69
Decorative Tack Panels	70

EGAN LECTERNS

Lecterns: Overview	71
How to Choose an Egan Lectern	72
Technology	
Audio Visual Height Adjustable Lectern	73
TecTern III	74
TecTern S2	75
TecTern TWO	76-77
TecTern	78-79
Contemporary	
202 EganLectern	80
202 Mobile Instruction Center	81
202 ADA	82
OVO	83
Classic	
Wood Veneer EganLectern	84
Wood Veneer ADA	85
Egan Accessories, Supplies & Mounting	86-90

PROGRAMS & SERVICES	91
Custom Color Matching, Egan Infinite Color Palette	92
Custom Stain	92
EganINK: Large format graphic printing	93
Egan Fabric Program	94

Cleaning Instructions	95
Purchase Order Requirements	96
Egan Standard Terms & Conditions	97
Freight Program & Egan Standard Warranty	98
Product Code Index	99

Dimension

EGAN

■ Dimension Stele

Designed specifically for free flow thinking, its clean aesthetic keeps the mind clear and free from distraction. With a 1" or 1/2" profile depth, Dimension Stele is impactful and complementary to any design or environment.

■ Dimension LINXX

Create a large, presentation board by linking Dimension boards. With a flexible design, install individual boards in an off set configuration for unique appearances.

■ Dimension Plus

All the benefits of Dimension Stele with a bold, prominent profile, in 2" or 3" depths.

■ Dimension Integral

Dimension Stele with the added functionality of a marker tray that seamlessly integrates into the board. Dimension Integral features a 3/4" groove to hold whiteboard markers in a fashion that is true to the minimalist design principles of the Dimension line.

■ Dimension Stratus

The knife-edge design gives Dimension Stratus a clean, modern and minimalist look that will instantly elevate your space. All edges of the board are chamfered back towards the wall at a 15-degree angle resulting in the board's floating appearance.

■ Dimension Tack

Dimension Tack is a frameless, squared edge profile that matches the design esthetic of Dimension Stele. Choose from over 200 fabric options from Guilford of Maine and Maharam or chose Egan EcoTack/Polyethylene Terephthalate (PET), a unique tackable infill that is environmentally friendly, sound-absorptive and fire retardant.

- 42% recycled content and 100% recyclable polyester
- Noise Reduction Coefficient (NRC) of 0.80
- Fire Retardant under ASTM E 84

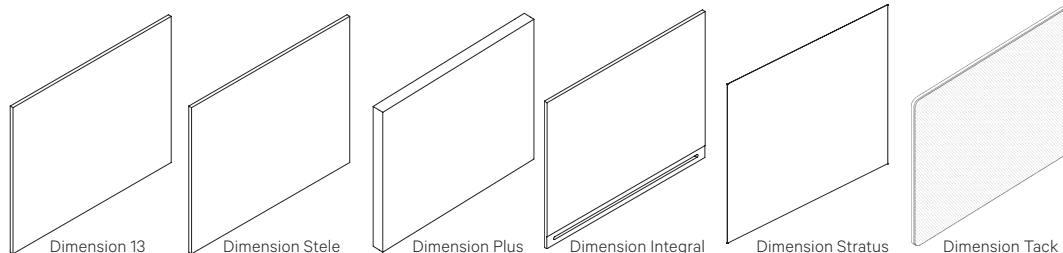

DIMENSION

**BUILT
TO INSPIRE**

Dimension

Presentation Boards

	Dimension Stele (1/2"d)	Dimension Stele (1"d)	Dimension Plus 2 (2"d)	Dimension Plus 3 (3"d)	Dimension Integral (1"d)	Dimension Stratus (1"d)	Dimension Tack EcoTack	Dimension Fabric Tack Standard	Dimension Fabric Tack Grade A
48"w x 36"h	\$1 310	\$1 340	\$1 645	\$1 810	\$1 540	\$1 655	\$740	\$780	\$885
48"w x 48"h	\$1 380	\$1 415	\$1 725	\$1 890	\$1 590	\$1 725	\$840	\$890	\$995
60"w x 48"h	\$1 510	\$1 540	\$1 860	\$2 070	\$1 810	\$1 860	\$1 095	\$1 155	\$1 270
72"w x 48"h	\$1 590	\$1 620	\$1 965	\$2 205	\$1 890	\$1 945	\$1 155	\$1 220	\$1 340
96"w x 48"h	\$1 800	\$1 840	\$2 235	\$2 465	\$2 100	\$2 150	\$1 290	\$1 365	\$1 490
120"w x 48"h	\$2 295	\$2 340	-	-	\$2 675	\$2 790	-	-	-
Projection Compatible									
77"w x 48"h 16:10	\$1 740	\$1 780	\$2 150	\$2 370	-	\$2 090	-	-	-
82"w x 51"h 16:9	\$1 925	\$1 965	\$2 340	\$2 590	-	\$2 255	-	-	-

Custom sizes available - Select next larger size and add \$150 to list / item
 COM (customer's own material) Upcharge: \$150 List handling fee. Customer required to purchase fabric

1. PRODUCT CODE

Code	Description
DM13	Dimension Stele: 1/2" Depth
DM	Dimension Stele: 1" Depth
DM2P	Dimension Plus: 2" Depth
DM3P	Dimension Plus: 3" Depth
DMI	Integral: Integrated Tray
DMS	Stratus: Knife Edge detail
DT	Dimension Tack 1-1/8" Depth

3. TRAY COLOR

Code	Description	Price
WH	White	\$ 0
CC	Custom Color	\$ 150

Applies to Integral (DMI) products only

2. EDGE COLOR

Code	Description	Price
WH	White	\$ 0
CC	Custom Color	\$ 150

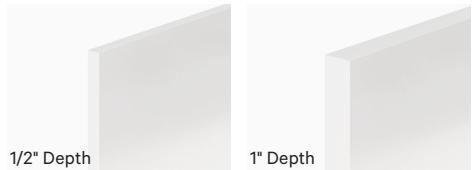

4. SURFACE

Dimension Tack (DT)	
F	Fabric
T	EcoTack/PET

For a full list of Standard and Grade A fabric options, visit egan.com/fabrics-and-textiles/

5. EGANK

Specify EganINK on EVS for a minimum upcharge of \$200 or \$25/ sqft

HOW TO ORDER

DM 60 48 WH WH T I

1. Product Code Width Height 2. Edge Color 3 Tray Color (Integral Only) 4. Surfaces (DT Only) 5. EganINK File # (supplied by Egan)

WHAT'S IN THE BOX

- Mounting cleats: ACWALMB-Z
- Two (2) assorted color Dry-Erase Markers
- One (1) EganCloth

Dimension LINXX & Flush Finish Options

Create a massive professional presentation surface with a monolithic, vanishing edge appearance with outstanding functionality; guaranteed-to-clean, projection-capable, and both standard and Egan NeoMagnet-compatible.

Dimension LINXX uses new Dimension Stele and Stratus (chamfered edge on outer edges only) cleat-mounted boards. To create Presentation Surfaces of varying heights and length combinations for a unique visual appearance.

Dimension LINXX

Select any combination of DM, DM13, or DMS boards to create your infinite length run. When combining Stratus, only outside boards will be Stratus. When selecting LINXX option, specify outside left (OL), inside board (IB) or outside right (OR). Specifying LINXX" Outside left (OL), inside board (IB) or outside right (OR) for \$90 CA list upcharge per segment.

When selecting the Flush Finish option:

The Dimension Stele optional Flush Finish is also available for boards specified for Dimension Stele LINXX. To specify this, order the outside left board with a Flush Finish Left (FFL) option, and the outside right board with a Flush Finish Right (FFR) option.

OFFSET Installation

The new Dimension LINXX design gives you the ability to install the individual boards vertically offset for unique appearance! Note: if specifying Flush Finish and also choosing to offset the installation, it should be noted that the offset board edges that are exposed (at either end of the common edge seam) are finished edges, with a 3/8" off the wall hover appearance.

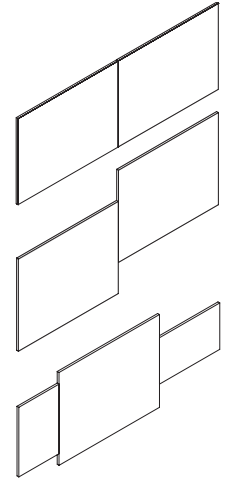

HOW TO ORDER

Flush Finish Option

FFL/FFR list \$150 per side

For a flush installation of your outside left board, please specify Flush Finish Left (FFL) in your product code.

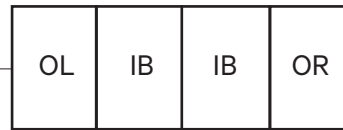

For a flush installation of your outside right board, please specify Flush Finish Right (FFR) in your product code.

Never specify Flush Finish

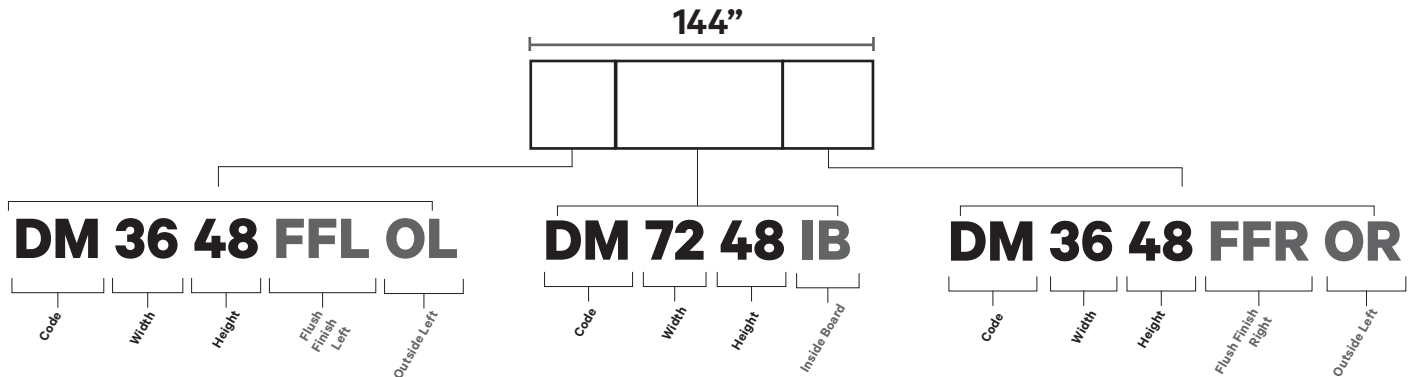

Architrave

■ Architrave Markerboard | EVS

Enhance your Egan whiteboard by integrating a natural, organic design that will provide a peaceful, calming space for ideas to flow. Available in 4 oak stains - Light Oak, Medium Oak, Dark Oak and Black Oak, visit Egan.com/oak-stains for more information.

■ Architrave | GlassWrite

Specify Egan GlassWrite into any Architrave frame. Available in over 1,050 colors at no extra cost and neo-magnet compatible. Visit Egan.com/infinite-color-palette to explore all 1,050 colors.

■ Architrave | EganAero

EganAero is an ultra thin, hi-tech glass, measuring only 1/50" (2mm) thin. EganAero reduces the drop shadow you get with typical glass. Available in over 1,050 colors at no upcharge and magnet compatible.

■ Architrave | Tack

Egan offers a wide range of tackable surfaces. Choose from over 200 fabric options from Guilford of Maine and Maharam or chose Egan EcoTack/Polyethylene Terephthalate (PET), a unique tackable infill that is environmentally friendly, sound-absorptive and fire retardant.

- 42% recycled content and 100% recyclable polyester
- Noise Reduction Coefficient (NRC) of 0.80
- Fire Retardant under ASTM E 84

Stains:

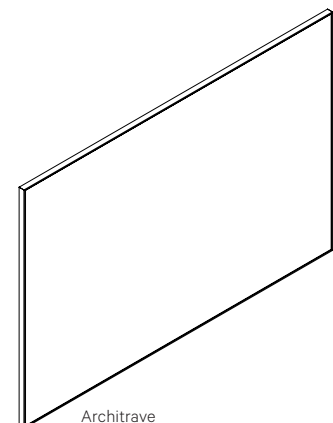

**BUILT
TO INSPIRE**

Architrave

	EVS	GlassWrite MAG	EganAero MAG	Tack EcoTack	Tack Standard Fabric	Tack Grade A Fabric
48" w x 36" h x 1 1/8" d	\$1 190	\$2 420	\$2 770	\$1 090	\$1 200	\$1 305
48" w x 48" h x 1 1/8" d	\$1 220	\$2 770	\$3 220	\$1 220	\$1 340	\$1 460
60" w x 48" h x 1 1/8" d	\$1 390	\$3 260	\$3 750	\$1 390	\$1 530	\$1 650
72" w x 48" h x 1 1/8" d	\$1 490	\$3 660	\$4 230	\$1 490	\$1 640	\$1 770
96" w x 48" h x 1 1/8" d	\$1 990	\$4 390	-	\$1 990	\$2 190	\$2 325
Projection Compatible						
77" w x 48" h 16:10	\$1 920	-	-	-	-	-
82" w x 51" h 16:9	\$1 960	-	-	-	-	-

Custom sizes available - Select next larger size and add \$150 to list / item COM (customer's own material) Upcharge: \$150 List handling fee. Customer required to purchase fabric

1. PRODUCT CODE

Code	Description
ARC	Architrave

2. INFILL

Code	Description
E	EVS
G	Glass: GlassWriteMAG
EA	Glass: EganAero
T	Tack

3. FRAME STAINS

Code	Description	Price
LO	Light Oak	\$ 0
MO	Medium Oak	\$ 0
DO	Dark Oak	\$ 0
BO	Black Oak	\$ 0
CC	Custom Stain	\$ 250

4. SURFACE

Glass: GlassWrite & EganAero	
WH	White
IP	Infinite Color Program
Visit egan.com or pantone.com for colors. Backpainted glass only.	
Tack	
F	Fabric
T	EcoTack/PET
For a full list of Standard and Grade A fabric options, visit egan.com/fabrics-and-textiles/	

5. EGANINK

Specify EganINK on EVS or Glass for a minimum upcharge of \$200 or \$25/ sqft

HOW TO ORDER

EVS

ARC E 48 48 LO I

1. Product Code 2. Infill Width Height 3. Frame 5. EganINK File #
supplied by Egan

GLASSWRITE

ARC G 48 48 BO WH I

1. Product Code 2. Infill Width Height 3. Frame 4. Surface 5. EganINK File #
supplied by Egan

TACK

ARC T 48 48 DO 463490-001

1. Product Code 2. INFILL Width Height 3. Frame Fabric #

WHAT'S IN THE BOX

Mounting cleats included.
For dry-erase surfaces, two (2) assorted color Dry-Erase Markers and one (1) EganCloth

■ Boxcore 19

Egan Boxcore 19 provides robust edges and clean contemporary esthetics. The Boxcore frame is clear anodized aluminum and sits flush against the wall, with the presentation surface 3/4" (19mm) proud from the wall. The frame features a low profile when viewed from the front. Integrated wallmounts mean the board can be mounted in a landscape or portrait orientation, switching between them easily. Available with EVS, Glass and Tack infills.

■ Boxcore 29

Boxcore 29 provides all the benefits of Boxcore 19 but has a bolder design esthetic with a thicker frame (29mm or 1 1/8"), giving the board a deeper profile, sitting more proud off the wall.

■ Standing Rigging

Egan Standing Rigging is an architectural-grade installation platform that brings a modern and unique tension wire installation without requiring complicated and custom-engineered architectural rigging. Install Boxcore 29 in any open space, at any height – all you need is a floor and ceiling as anchor points. The finished installation features the board suspended in midair on a simple tensioned wire rope (1x19 SSAC) assembly – with all the parts in the box from Egan. Specify dual infills - EVS, Tackable Fabric or EcoTack - for Boxcore 29 when used with Standing Rigging.

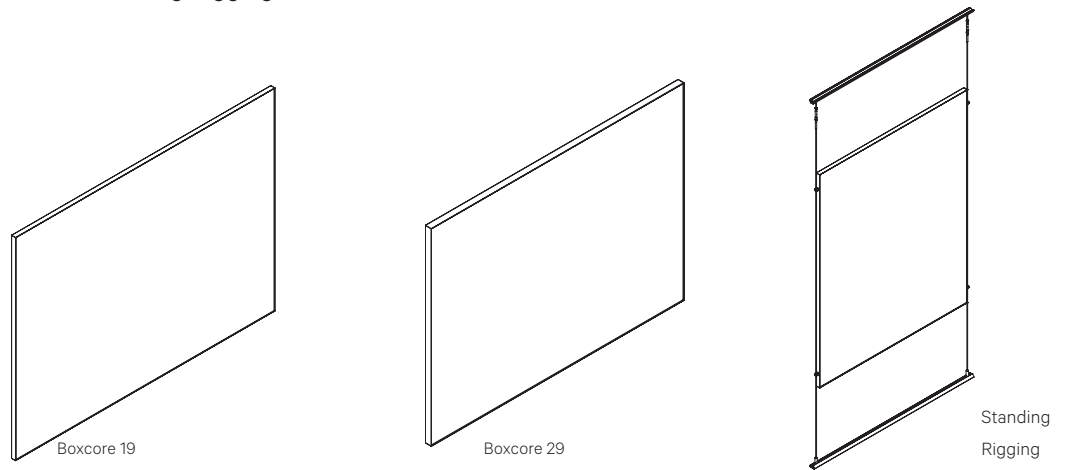

Product	Thickness
Décor Panel EganAero	19mm
GlassWrite MAG	20mm
Dimension Tack Boxcore (EcoTack)	25mm
Dimension Tack Boxcore (Fabric)	28mm +/- Fabric Thickness
Dimension Stele Décor Panel	29mm
Dimension Tack Boxcore (EcoTack)	34mm
Dimension Tack Boxcore (Fabric)	37mm +/- Fabric Thickness

**BUILT
TO INSPIRE**

Boxcore 19

	EVS	GlassWrite MAG	EganAero MAG	Tack EcoTack	Tack Standard Fabric	Tack Grade A Fabric
48" w x 36" h x 3/4" d	\$960	\$2 190	\$2 540	\$960	\$955	\$1 065
48" w x 48" h x 3/4" d	\$1 110	\$2 660	\$3 110	\$1 110	\$1 220	\$1 335
60" w x 48" h x 3/4" d	\$1 160	\$3 030	\$3 520	\$1 160	\$1 275	\$1 400
72" w x 48" h x 3/4" d	\$1 290	\$3 460	\$4 030	\$1 290	\$1 420	\$1 550
96" w x 48" h x 3/4" d	\$1 790	\$4 190	-	\$1 790	\$1 970	\$2 105
120" w x 48" h x 3/4" d	\$2 250	-	-	-	-	-

Projection Compatible						
77" w x 48" h 16:10	\$1 390	-	-	-	-	-
82" w x 51" h 16:9	\$1 650	-	-	-	-	-

Boards are single sided wallmounted
 Custom sizes available - Select next larger size and add \$150 to list / item
 COM (customer's own material) Upcharge: \$150 List handling fee. Customer required to purchase fabric
 Custom Color Frame upcharge: \$150/ product

1. PRODUCT CODE

Code	Description
PBB	EVS
DGMB	Glass: GlassWrite MAG
EAB	Glass: EganAero
DTB	Tack

Boxcore 19 & 29 use the same product code; call out frame selection in description on your Purchase Order (PO).

3. FRAME COLOR

Code	Description	Price
CA	Clear Anodized	\$ 0
WH	White	\$ 150
BL	Black	\$ 150
CC	Custom Color	\$ 150

2. SURFACE

Glass: GlassWrite & EganAero	
WH	White
IP	Infinite Color Program
Visit egan.com or pantone.com for colors. Backpainted glass only.	
Tack	
F	Fabric
T	EcoTack/PET

4. EGANINK

Specify EganINK on EVS or Glass for a minimum upcharge of \$200 or \$25/ sqft

WHAT'S IN THE BOX

Mounting cleats included
 Two (2) assorted color Dry-Erase Markers
 One (1) EganCloth

HOW TO ORDER

EVS

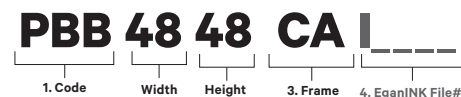

GLASS

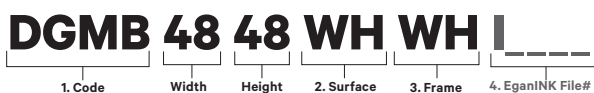

TACK



Boxcore 29

Presentation Boards

	EVS	GlassWrite MAG	Tack EcoTack	Tack Standard Fabric	Tack Grade A Fabric
48" w x 36" h x 1 1/8" d	\$1 190	\$2 420	\$1 090	\$1 200	\$1 305
48" w x 48" h x 1 1/8" d	\$1 220	\$2 770	\$1 220	\$1 340	\$1 460
60" w x 48" h x 1 1/8" d	\$1 390	\$3 260	\$1 390	\$1 530	\$1 650
72" w x 48" h x 1 1/8" d	\$1 490	\$3 660	\$1 490	\$1 640	\$1 770
96" w x 48" h x 1 1/8" d	\$1 990	\$4 390	\$1 990	\$2 190	\$2 325
120" w x 48" h x 1 1/8" d	\$2 470	-	-	-	-

Projection Compatible					
77" w x 48" h 16:10	\$1 920	-	-	-	-
82" w x 51" h 16:9	\$1 960	-	-	-	-

Boards are single sided wallmounted
 Custom sizes available - Select next larger size and add \$150 to list / item
 COM (customer's own material) Upcharge: \$150 List handling fee. Customer required to purchase fabric
 Custom Color Frame upcharge: \$150/ product

1. PRODUCT CODE

Code	Description
DMB	EVS
DGMB	Glass: GlassWriteMAG
EAB	Glass: EganAero
DTB	Tack

Boxcore 19 & 29 use the same product code; call out frame selection in description on your Purchase Order (PO).

2. SURFACE

Glass: GlassWrite & EganAero	
WH	White
IP	Infinite Color Program
Visit egan.com or pantone.com for colors. Backpainted glass only.	

Tack	
F	Fabric
T	EcoTack/PET

3. FRAME COLOR

Code	Description	Price
CA	Clear Anodized	\$ 0
WH	White	\$ 150
BL	Black	\$ 150
CC	Custom Color	\$ 150

4. EGANK

Specify EganINK on EVS or Glass for a minimum upcharge of \$200 or \$25/ sqft

WHAT'S IN THE BOX

Mounting cleats included.
 Two (2) assorted color Dry-Erase Markers
 One (1) EganCloth

HOW TO ORDER

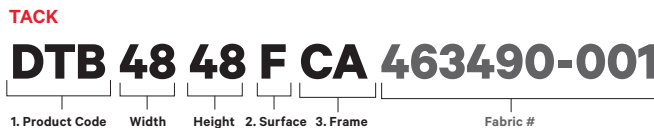

Egan Standing Rigging

Egan Presentation Boards are available wall mount, track mount, wallcovering, freestanding, mobile, and more: now you can specify Egan Boxcore 29 in open environments! Egan Standing Rigging is an all-new architectural-grade installation platform that brings a modern and unique tension wire installation. Install Boxcore 29 in any open space, at any height – all you need is a floor and ceiling as anchor points. The finished installation features the board suspended in midair on a simple tensioned wire rope (1x19 SSAC) assembly – with all the parts in the box from Egan.

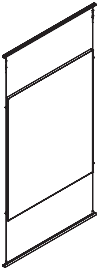

Presentation Boards

Where To Specify Standing Rigging

Egan Standing Rigging can bring high functionality and modern design esthetic to almost any space. Consider complementing other architectural tension wire assemblies (live walls, rails, etc), creating workspaces in open floorplans, or even to install presentation boards in front of walls which cannot have fixtures (glass walls, demountable walls, partitions, etc).

How To Specify Boards

Egan Standing Rigging is solely available on Boxcore 29. These boards have two additional features: first, they are optionally manufactured in a double-sided configuration; second, they feature mounting holes on the Boxcore frame for the Standing Rigging hardware.

How To Specify The Standing Rigging Kit

Order one kit per board to be installed. A Standing Rigging Kit includes hardware suitable for installing one board (of any standard size) with a floor-to-ceiling distance of up to 12'. For greater heights or long continuous runs of boards - please call Customer Service.

What's In The Box

Ship with Two (2) assorted color Dry-Erase Markers One (1) EganCloth.

The kit consists of track, wire, board mounts (stops and eye bolts) and termination hardware. What is not included: installation hardware (to mount the track), tools, and the tension gauge. Wire tension of 350lbs is recommended to stabilize the installation, and a wire tension gauge is required to measure this. If cutting the wire, the cut must be clean. If the installer does not have a tension gauge or wire cutter (appropriate for SSAC 1x19, such as Felco cutter), these are widely available and also available from Egan.

Installation

1. Install the upper and lower track.
2. Slide the turnbuckle into the upper track, with the wires hanging down. The wires have been fixed to the turnbuckle termination at the factory.
3. Screw the eye bolts into the factory-prepared holes on the Dimension Stele Boxcore frame.
4. Feed the wire through the eyebolts and the stop collars, temporarily fixing the stop collars to hold the board in place.
5. Cut off any excess wire and insert the wire into the quick connect fitting.
6. Insert the fitting into the lower track and tighten the turnbuckle to 350 lbs (gauge required).
7. True the board and tighten the stop clamps.

Code	Description	Price
ACESR-KIT	Egan Standing Rigging Kit	\$680
ACESR-KIT-ADD	For use with ACESR-KIT when installing 2 or more boards on the same vertical wire	\$460
ACESR-WC	Wire Cutter	Inquire*
ACESR-TG	Tension Gauge	Inquire*

PRICING SHOWN PER SIDE OF BOXCORE 29

	EVS Code: E	EganAero MAG Code: EA	Tack EcoTack Code: T	Tack Standard Fabric Code: F	Tack Grade A Fabric Code: F
48" w x 36" h x 1 1/8" d	\$1 490	\$4 720	\$1 490	\$1 610	\$1 780
48" w x 48" h x 1 1/8" d	\$1 670	\$5 710	\$1 670	\$1 795	\$1 980
60" w x 48" h x 1 1/8" d	\$1 930	\$6 720	\$1 930	\$2 080	\$2 270
72" w x 48" h x 1 1/8" d	\$2 050	\$7 610	\$2 050	\$2 210	\$3 395
96" w x 48" h x 1 1/8" d	\$2 770	Inquire	\$2 770	\$2 980	\$3 180
120" w x 48" h x 1 1/8" d	\$3 410	Inquire	-	-	-

GLASS DOUBLE SIDED BOXCORE 29 PRICING

	GlassWrite MAG Code: GG
48" w x 36" h x 1 1/8" d	\$4 020
48" w x 48" h x 1 1/8" d	\$4 830
60" w x 48" h x 1 1/8" d	\$5 750
72" w x 48" h x 1 1/8" d	\$6 470
96" w x 48" h x 1 1/8" d	\$7 630
120" w x 48" h x 1 1/8" d	-

Projection Compatible

77" w x 48" h 16:10	-
82" w x 51" h 16:9	-

Projection Compatible					
77" w x 48" h 16:10	\$2 490	-	-	-	-
82" w x 51" h 16:9	\$2 950	-	-	-	-

HOW TO ORDER

GLASS

DMB 48 48 R G G WH WH CA I

Product Code Width Height Standing Rigging Side 1: Infill Side 2: Infill Side 1: Surface Color/Fabric Side 2: Surface Color/Fabric Frame 4. EganNK File # supplied by Egan

Classic Boards

■ Aluminum Frame | Markerboard & Tackboard

Aluminum Frame Markerboards feature EVS™ surface or EganBoard Porcelain framed in clear anodized aluminum frame with precision square mitered corners. Guaranteed-to-clean and never warp, Egan Aluminum Frame Markerboards are magnet-compatible.

■ Linked Aluminum Frame

Link any combination of Markerboards and Tackboards to create a superior quality communication wall.

■ Aluminum Frame w/ Full Length Integrated Tray

Aluminum Frame Markerboard integrated with the exquisite custom-fit Full Length Aluminum Marker Tray. The Tray's clean edges and contemporary design blends perfectly with the Clear Anodized frame.

■ Hardwood Frame | Markerboard & Tackboard

A solid hardwood frame with a 1/2" bullnose edge. Satin lacquer in an open-grain finish gives this robust markerboard excellent appeal. Available in EVS, Porcelain or Tack.

■ Linked Hardwood Frame

Featuring high-performance EVS or Porcelain with hardwood frames - 1" wood frame with a 1/2" bullnose detail. Link any combination of Linked Markerboards and Tackboards to create a superior quality communication wall.

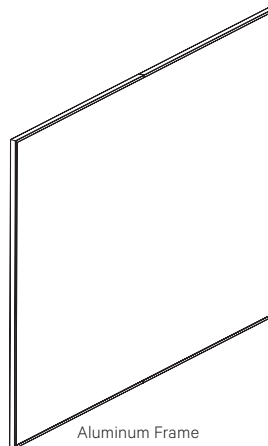

Aluminum Frame

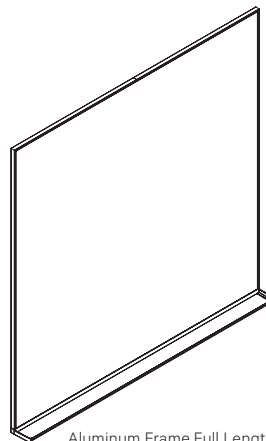

Aluminum Frame Full Length Tray

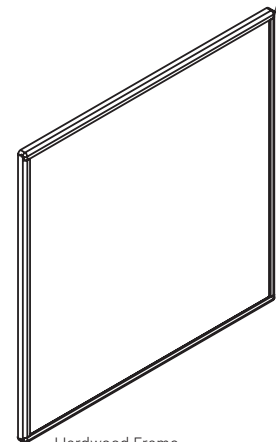

Hardwood Frame

Aluminum Frame Markerboard & Tackboard

Presentation Boards

	EVS	Porcelain	Tack Standard Fabric	Tack Grade A Fabric	Tack Cork
24"w x 36"h	\$380	\$400	\$440	\$535	\$535
48"w x 36"h	\$580	\$620	\$670	\$780	\$780
48"w x 48"h	\$690	\$740	\$780	\$895	\$895
60"w x 48"h	\$810	\$860	\$880	\$1 005	\$1 005
72"w x 48"h	\$930	\$1 010	\$980	\$1 010	\$1 110
96"w x 48"h	\$1 090	\$1 220	\$1 080	\$1 200	\$1 200
120"w x 48"h	\$1 390	-	-	-	-

Projection Compatible	
77"w x 48"h 16:10	\$995
82"w x 51"h 16:9	\$1 190

Custom Color Frame: Additional \$150
 Custom sizes available - Select next larger size and add \$150 to list / item
 COM (customer's own material) Upcharge: \$150 List handling fee. Customer required to purchase fabric

1. PRODUCT CODE

Code	Description
MES	EVS Square Frame
MDMS	Porcelain Square Frame
MDTS	Tack Square Frame

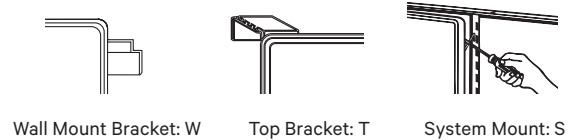

2. MOUNT

Code	Description
W	Wall Mount
T	Top Bracket
S	System Mount

Top Mount brackets are universal and can be easily adjusted to accommodate any workstation panel measuring from 1 3/4" to 2 3/4" thick. Adjustable by 1/8" increments. Due to weight restraints 72"w x 48"h, 85" x 53", 96"w x 48"h and 120" x 48" boards are not available with Top Bracket or System Mount. Brackets are aluminum with a clear anodized finish. Custom colors are not available on the brackets. Plastic protective sleeves are included to assure no damage is caused to the system. For panels 2 3/4"-4" deep please specify EOEX at \$12.

3. EGANINK

Specify EganINK on EVS for a minimum upcharge of \$200 or \$25/ sqft
 Not available on Porcelain

HOW TO ORDER

DRY ERASE
MES 60 48 W I
 1. Product Code Width Height 2. Mount 3. EganINK File# (supplied by Egan)

TACK
MDTS 72 48 W 463490-001
 1. Product Code Width Height 2. Mount Fabric #

WHAT'S IN THE BOX

Mounting brackets as specified
 Four (4) assorted color, Dry-Erase Markers
 One (1) EganCloth, One (1) Marker Tray

NOTES

For a full list of Standard and Grade A fabric options, visit egan.com/fabrics-and-textiles/

Linked Aluminum Frame

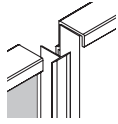

Board Link Detail

	EVS	Porcelain	Tack Standard Fabric	Tack Grade A Fabric	Tack Cork
24"w x 36"h	\$490	\$540	\$560	\$660	\$660
48"w x 36"h	\$610	\$690	\$695	\$800	\$800
48"w x 48"h	\$740	\$790	\$800	\$920	\$920
60"w x 48"h	\$870	\$940	\$915	\$1 035	\$1 035
72"w x 48"h	\$1 010	\$1 070	\$1035	\$1 160	\$1 160
96"w x 48"h	\$1 190	\$1 260	\$1 230	\$1 365	\$1 365
120"w x 48"h	\$1 490	-	-	-	-

Custom Color Frame: Additional \$150

Custom sizes available - Select next larger size and add \$150 to list / item COM (customer's own material) Upcharge: \$150 List handling fee. Customer required to purchase fabric

Presentation Boards

1. PRODUCT CODE

Code	Description
I	Linked Aluminum Frame

2. SURFACE

Dry Erase	
E	EVS
M	Porcelain
T	Fabric

For a full list of Standard and Grade A fabric options, visit egan.com/fabrics-and-textiles/

EGANINK

Specify EganINK on EVS for a minimum upcharge of \$200 or \$25/ sqft
Not available on Porcelain

3. CORNERS

Square	Description
S	Outside Left and Outside Right boards only

WHAT'S IN THE BOX

Mounting brackets as specified
Four (4) assorted color Dry-Erase Markers
One (1) EganCloth

4. POSITION

Code	Description
OL	Outside Left
OR	Outside Right

5. MOUNT

Code	Description
W	Wall Mount

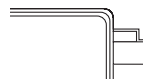

HOW TO ORDER

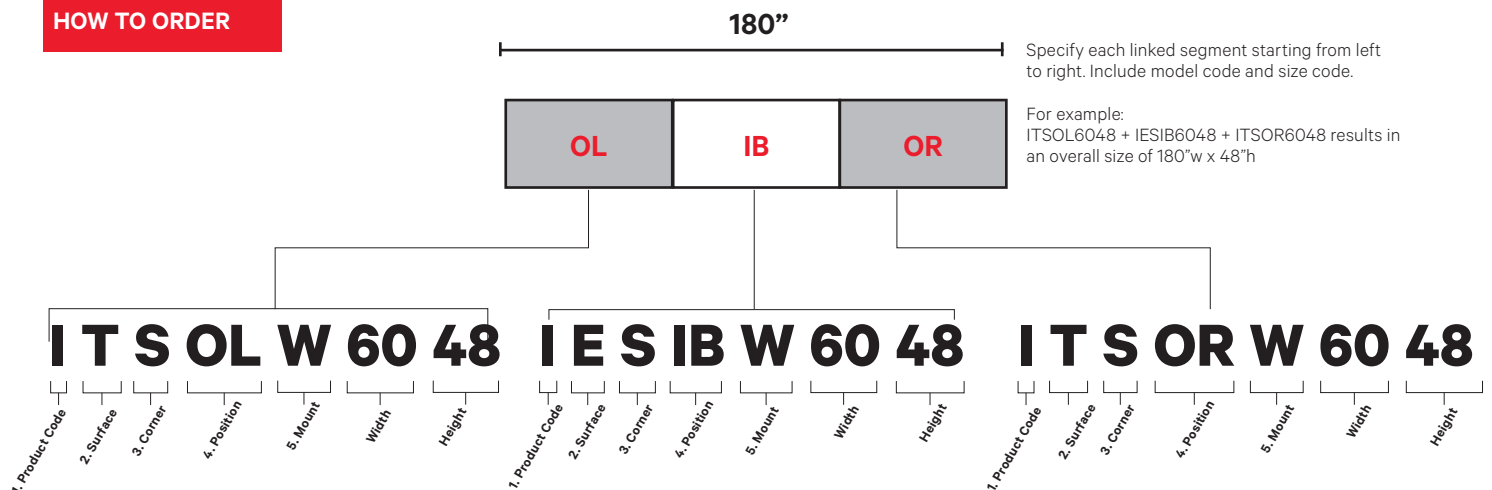

Markerboard with Integrated Full Length Marker Tray

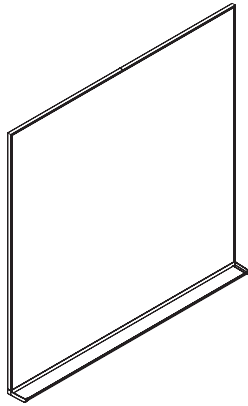

	EVS	Porcelain
24"w x 36"h	\$440	\$490
48"w x 36"h	\$650	\$690
48"w x 48"h	\$770	\$795
60"w x 48"h	\$920	\$950
72"w x 48"h	\$1 050	\$1 195
96"w x 48"h	\$1 250	\$1 320
120"w x 48"h	\$1 570	-

Custom Color Frame: Additional \$150
 Custom sizes available - Select next larger size and add \$150 to list per item

Presentation Boards

1. PRODUCT CODE

Code	Description
MFTES	EVS Square Frame
MFTMS	Porcelain Square Frame

2. MOUNT

Code	Description
W	Wall Mount
T	Top Bracket
S	System Mount

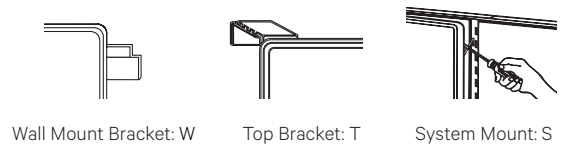

Top Mount brackets are universal and can be easily adjusted to accommodate any workstation panel measuring from 1 3/4" to 2 3/4" thick. Adjustable by 1/8" increments. Due to weight restraints 72"w x 48"h, 85" x 53", 96"w x 48"h and 120" x 48" boards are not available with Top Bracket or System Mount. Brackets are aluminum with a clear anodized finish. Custom colors are not available on the brackets. Plastic protective sleeves are included to assure no damage is caused to the system. For panels 2 3/4"-4" deep please specify EOEX at \$12.

3. EGANINK

Specify EganINK on EVS for a minimum upcharge of \$200 or \$25/ sqft
 Not available on Porcelain

HOW TO ORDER

MFTE 60 48 W I

1. Product Code Width Height 2. Mount Option 3. EganINK File # (supplied by Egan)

WHAT'S IN THE BOX

- Mounting brackets as specified
- Four (4) assorted color Dry-Erase Markers
- One (1) EganCloth

Hardwood Frame Markerboard & Tackboard

Presentation Boards

	EVS	Porcelain	Tack Standard Fabric	Tack Grade A Fabric	Tack Cork
48" w x 36" h	\$990	\$1 060	\$1 055	\$1 165	\$1 165
48" w x 48" h	\$1 110	\$1 180	\$1 180	\$1 300	\$1 300
60" w x 48" h	\$1 220	\$1 290	\$1 310	\$1 430	\$1 430
72" w x 48" h	\$1 360	\$1 460	\$1 465	\$1 590	\$1 590
96" w x 48" h	\$1 570	\$1 660	\$1 640	\$1 775	\$1 775

Custom Color Frame: Additional \$150
 Custom sizes available - Select next larger size and add \$150 to list / item
 COM (customer's own material) Upcharge: \$150 List handling fee. Customer required to purchase fabric

1. PRODUCT CODE

Code	Description
MEW	EVS
MDMW	Porcelain
MDTW	Tack

For a full list of Standard and Grade A fabric options, visit egan.com/fabrics-and-textiles/

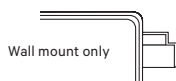

2. STAINS

Code	Description
LO	Light Oak
MO	Medium Oak
DO	Dark Oak
BO	Black Oak
MA	Mahogany
CH	Cherry
MP	Natural Maple
WA	Walnut
CS	Custom Stain available Add \$250 to list, per board

3. EGANINK

Specify EganINK on EVS for a minimum upcharge of \$200 or \$25/ sqft
 Not available on Porcelain

HOW TO ORDER

EVS

MEW 48 48 CH I _____

1. Product Code Width Height 2. Stains 3. EganINK File # (supplied by Egan)

TACK

MDTW 24 36 MP 463490-001

1. Product Code Width Height 2. Stains Fabric #

WHAT'S IN THE BOX

Mounting brackets as specified
 For Dry-erase surfaces, two (2) assorted color Dry-Erase Markers, one (1) EganCloth

Linked Hardwood Frame



Edge detail

	EVS	Porcelain	Tack Standard Fabric	Tack Grade A Fabric	Tack Cork
48" w x 36" h	\$1 020	\$1 110	\$1 065	\$1 175	\$1 175
48" w x 48" h	\$1 140	\$1 220	\$1 190	\$1 300	\$1 300
60" w x 48" h	\$1 260	\$1 390	\$1 330	\$1 455	\$1 455
72" w x 48" h	\$1 410	\$1 520	\$1 485	\$1 610	\$1 610
96" w x 48" h	\$1 620	\$1 720	\$1 670	\$1 805	\$1 805

Custom sizes available - Select next larger size and add \$150 to list / item
COM (customer's own material) Upcharge: \$150 List handling fee. Customer required to purchase fabric

1. PRODUCT CODE

Code	Description
IWE	EVS
IWB	Porcelain
IWT	Tack

STAINS

Code	Description
LO	Light Oak
MO	Medium Oak
DO	Dark Oak
BO	Black Oak
MA	Mahogany
CH	Cherry
MP	Natural Maple
WA	Walnut
CS	Custom Stain available Add \$250 to list, per board

2. SURFACE

Dry Erase	
E	EVS
B	Porcelain

Tack	
T	Fabric

For a full list of Standard and Grade A fabric options, visit egan.com/fabrics-and-textiles/

3. POSITION

Code	Description
OL	Outside Left
IB	Inside Board
OR	Outside Right

EGANINK

Specify EganINK on EVS for a minimum upcharge of \$200 or \$25/ sqft
Not available on Porcelain

HOW TO ORDER

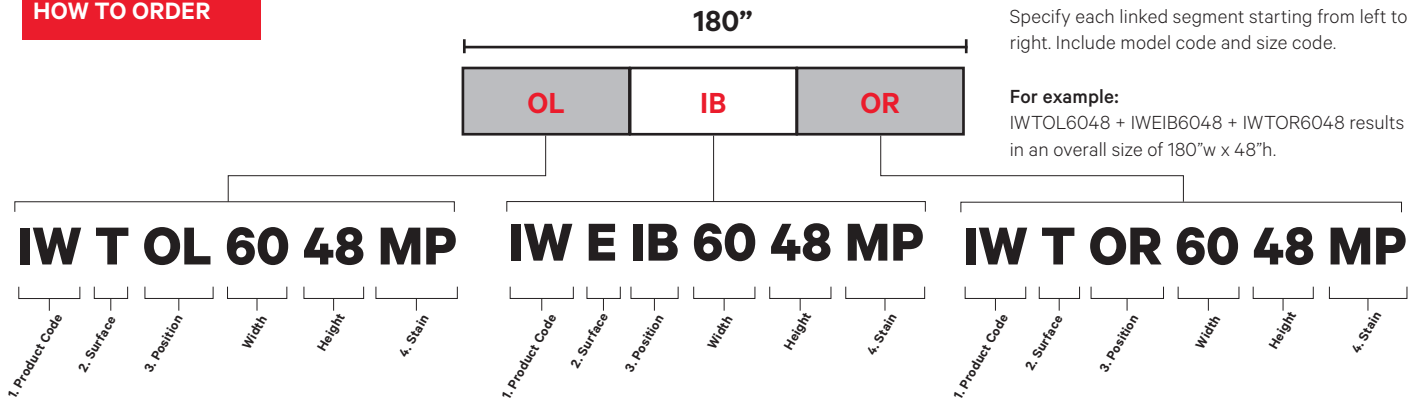

WHAT'S IN THE BOX

Wall mount bracket and link connectors
For dry-erase surfaces, two (2) assorted color Dry-Erase Markers, one (1) EganCloth

EganAero Glass Markerboards

■ EganAero Hover

EganAero Hover is an ultra-thin high-tech glass. It is installed with a cleat mount, giving the effect of it floating off the wall. Neo-Magnet compatible.

■ EganAero MAG Boxcore

The Egan Boxcore frame provides a 19mm 3/4" (19mm) thin beveled aluminum frame that sits flush against the wall. Neo-Magnet compatible.

■ EganAero Architrave

Enhance your frame with Architrave, an Oak species available in 4 different stain options. Neo-Magnet compatible.

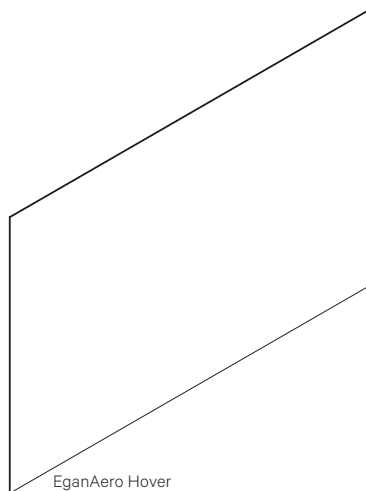

EganAero Hover

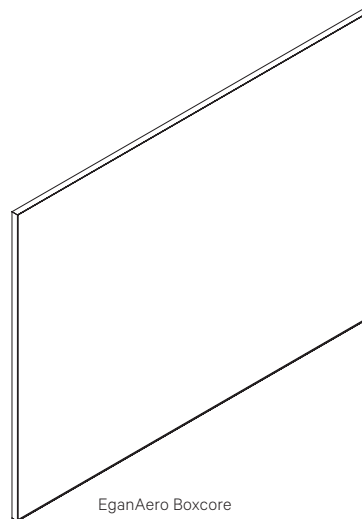

EganAero Boxcore

**BUILT
TO INSPIRE**

EganAero

	Aero Hover	Aero Boxcore 19	Aero Architrave
48" w x 36" h	\$2 110	\$2 540	\$2 770
48" w x 48" h	\$2 660	\$3 110	\$3 220
60" w x 48" h	\$2 920	\$3 520	\$3 750
72" w x 48" h	\$3 410	\$4 030	\$4 230
96" w x 48" h		Inquire	

1. PRODUCT CODE

Code	Description
EAH	EganAero Hover
EAB	EganAero Boxcore
ARCEA	Egan Aero Architrave
Boxcore & Architrave frame of 29mm (1-1/8")	

2. SURFACE

Code	Description	Price
WH	White	\$0
CC	Custom Color	\$150
IP	Infinite Color Palette	\$0
Visit egan.com or pantone.com for colors. Backpainted glass only.		

Description	Price
Brushed Aluminum	\$0
Grey Oak	\$0
Light Oak	\$0
Maple	\$0

3. FRAME

ARCHITRAVE FRAME STAINS		
Code	Description	Price
LO	Light Oak	\$ 0
MO	Medium Oak	\$ 0
DO	Dark Oak	\$ 0
BO	Black Oak	\$ 0
CS	Custom Stain	\$ 250

BOXCORE FRAME COLORS		
Code	Description	Price
CA	Clear Anodized	\$ 0
WH	White	\$ 150
BL	Black	\$ 150
CC	Custom Color	\$ 150

4. EGANINK

Specify EganINK on Glass minimum upcharge of \$200 or \$25/ sqft

WHAT'S IN THE BOX

Mounting brackets as specified
Two (2) assorted color Dry-Erase Markers
Two (2) NeoMagnets
One (1) EganCloth

HOW TO ORDER



GlassWrite Markerboards

■ GlassWrite | Clear & Frosted

All Egan GlassWrite product are made with high quality, low iron tempered safety glass with a 1/5" (5mm) thickness - stanchion mount only.

■ GlassWrite | Colors

Bring color to your workplace! Specify from over 1,000 standard colors at no upcharge - stanchion mount only.

■ GlassWrite Shapes

We work with Designers and Clients to develop custom glass solutions design around your space. Contact your local Rep or our Customer Service team for more information.

■ GlassWriteMAG

All the benefits of GlassWrite Color with added functionality of magnet compatibility - cleat mount only.

■ GlassWriteMAG Boxcore

The Egan Boxcore frame provides a 3/4" (19mm) thin bezeled aluminum frame that sits flush against the wall.

■ GlassWrite Envoy

GlassWrite Envoy brings a high design element to your artwork, graphics, care board, wayfinding, or any other art you envision. Change your artwork easily, and without the use of tools - stanchion or cleat mount available.

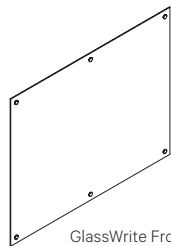

GlassWrite Frosted & Clear
GlassWrite Colors

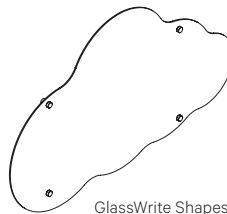

GlassWrite Shapes

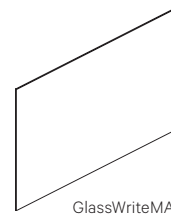

GlassWriteMAG

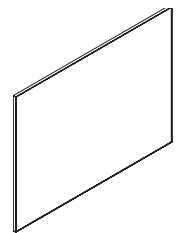

GlassWriteMAG
Boxcore

**BUILT
TO INSPIRE**

Egan GlassWrite is built from a guaranteed-to-clean, crystal clear, low iron tempered safety glass for high clarity. All GlassWrite products feature sparkling field depth and are guaranteed-to-clean. A frameless 1/4" (5 mm) thick glass dry erase board, GlassWrite boards are finished with polished edges and are available as clear or frosted, in color, as neo-magnet compatible.

	Clear	Frosted	Color Stanchion	Color Cleat	GlassWrite Shapes	GlassWrite MAG	GlassWriteMAG Boxcore 29mm	GlassWriteMAG Boxcore 19mm	GlassWrite MAG Architrave
48"w x 36"h	\$1 240	\$1 240	\$1 470	\$1 310	Call for Spot Quote	\$1 685	\$2 420	\$2 190	\$2 420
48"w x 48"h	\$1 410	\$1 410	\$1 870	\$1 610		\$1 995	\$2 770	\$2 660	\$2 770
60"w x 48"h	\$1 460	\$1 460	\$1 990	\$1 660		\$2 300	\$3 260	\$3 030	\$3 260
72"w x 48"h	\$1 790	\$3 180	\$2 370	\$2 090		\$2 740	\$3 660	\$3 970	\$3 660
96"w x 48"h	\$2 180	\$3 940	\$2 970	\$2 490		\$3 365	\$4 390	\$4 860	\$4 390
120"w x 48"h	\$2 560	\$2 560	\$3 620	\$3 250		\$4 175	-	-	-

Custom sizes available - Select next larger size and add \$150 to list / item

MATTE GLASSWRITE

GlassWrite products are also offered in a Matte finish. Matte GlassWrite has a low gloss finish to reduce glare from ambient light.

	Clear	Color Cleat	GlassWrite MAG	GlassWrite MAG Boxcore 19	GlassWrite MAG Architrave
48"w x 36"h	\$1 490	\$1 490	\$1 890	\$2 450	\$2 580
48"w x 48"h	\$1 730	\$1 930	\$2 290	\$3 030	\$3 150
60"w x 48"h	\$1 850	\$2 060	\$2 660	\$3 460	\$3 660
72"w x 48"h	\$2 280	\$2 590	\$3 180	\$2 730	\$4 180
96"w x 48"h	\$2 790	\$3 140	\$3 940	\$3 610	\$5 050
120"w x 48"h	\$3 360	\$4 050	\$4 890	-	-

Custom sizes available - Select next larger size and add \$150 to list / item

1. PRODUCT CODE

Code	Description	Mount
DGC	GlassWrite Clear	P
DG	GlassWrite Color	P & C
DGM	GlassWrite MAG	C
DGMB	GlassWrite Boxcore	C
ARC	GlassWrite Architrave	C

2. MOUNT

Code	Description
P	Stanchion
C	Cleat

3. SURFACE

*Applicable for DG, DGM AND DGMB only
*Visit egan.com or pantone.com for colors.

Code	Description	Price
WH	White	\$ 0
IP	Infinite Color Program	\$ 0
CC	Custom Color	\$ 150

Code	Description	Price
MATWH	Matte White	\$ 0
MATIP	Matte Color	\$ 0
MATCC	Matte Custom Color	\$ 150

4. FRAME

BOXCORE FRAME COLORS

Code	Description	Price
CA	Clear Anodized	\$ 0
CC	Custom Color	\$ 150

ARCHITRAVE FRAME STAINS

Code	Description	Price
LO	Light Oak	\$ 0
MO	Medium Oak	\$ 0
DO	Dark Oak	\$ 0
BO	Black Oak	\$ 0
CC	Custom Stain	\$ 250

5. EGANINK

Specify EganINK on Glass for a minimum upcharge of \$200 or \$25/ sqft

How to Order and GlassWrite LINXX on next page (page 26)

GlassWrite™ & GlassWrite LINXX

HOW TO ORDER

DGC

DGC 60 48 P I _____



DG | DGM

DGM 60 48 C MATIP3-30-7 I _____



DGMB

DGMB 60 48 C 19 WH CA I _____



ARCG

ARCG 60 48 C WH LO I _____



WHAT'S IN THE BOX

Mount specified included, Two (2) assorted color Dry-Erase Markers, One (1) EganCloth, Magnetic GlassWrite boards ONLY Two (2) Neo-Magnets.

GlassWrite LINXX

Create a massive professional presentation surface with outstanding functionality, and guaranteed-to-clean. Specify with Egan Ink to customize your GlassWrite LINXX boards.

Select a combination of GlassWrite, GlassWrite Colors (DG) or GlassWrite MAG (DGM), boards to create your infinite length run. GlassWrite LINXX is installed cleat mount with a hover appearance. The presentation surface is linked using a vertical ABS black plastic extrusion.

LINXX. Code: ACDGLINK-KIT###. Two each ACDGLINK-KIT 48" required. List charge of \$60 per link.

Standard Sizes: 48, 60, 72, 96", specify 2 each 60" lengths for 120" high boards. Link kit ACDGLINK-KIT### adds 1/8" per seam to overall width.

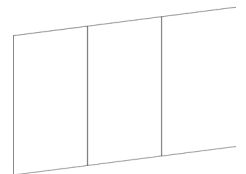

HOW TO ORDER

144-1/4"

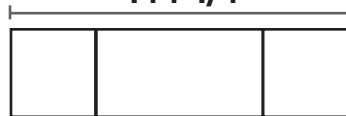

Specifying LINXX:

2 each ACDGLINK-KIT48 required.
List charge of \$60 per link.

DG 36 48 C WH



DG 72 48 C WH



DG 36 48 C WH



ACDGLINK-KIT48 ACDGLINK-KIT48

GlassWrite Envoy

A display and presentation board providing patient, guest or signage solution. GlassWrite Envoy is designed for continued and dynamic use with its dry-erase, guaranteed-to-clean, crystal clear glass covering. Leverage artwork, charts, images and information in lightweight boards, which can be easily switched without the use of tools. To change your artwork, simply slide your boards under the GlassWrite surface.

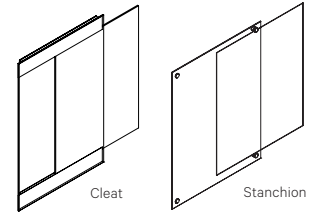

	Stanchion Mount	Cleat Mount	Optional Décor Insert*	Optional EganINK on top/bottom (3" border) for cleat mount only
24"w x 36"h (Standard Poster)	\$660	\$760	*\$190	**90
27"w x 40"h (Movie Poster)*	\$770	\$890	*\$240	**115
36"w x 48"h	\$1 590	\$1 830	*360	**180
40"w x 60"h (Bus Stop Poster)	\$1 840	\$2 110	*530	**250

Custom sizes available - Select next larger size and add \$150 to list / item
 *Decor panel insert sold separately, add price in chart above to overall list price.
 **Optional EganINK on top and bottom (3" border) for cleat mount Envoy

1. PRODUCT CODE

Code	Description
DGE	GlassWrite Envoy

2. MOUNT

Code	Description
SP	Stanchion
C	Cleat

Top and bottom of cleat mount is NeoMagnet compatible.

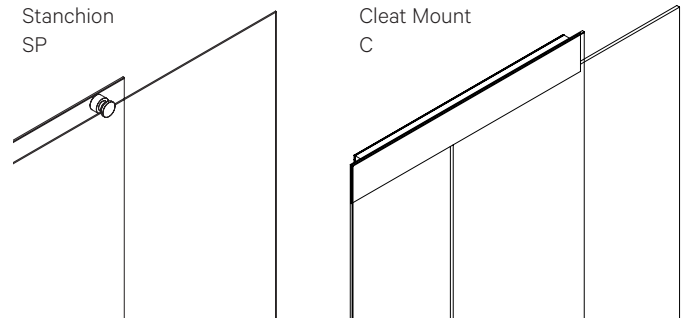

3. EGANINK

Specify EganINK on Glass for a minimum upcharge of \$200 or \$25/ sqft

HOW TO ORDER

DGE 60 48 SP I _____

1. Product Code Width Height 2. Mount 3. EganINK File (supplied by Egan)

WHAT'S IN THE BOX

Mount specified included
 Two (2) assorted color Dry-Erase Markers
 One (1) EganCloth

Glass Markerboards

Egan Wall System

■ VersaPRO® Wallcovering

Egan VersaPRO® high performance EVS™ dry-erase surface is designed for quick and easy installation by qualified installers, and is manufactured from similar materials to VersaJOT. Optional EganSystem Track framing is recommended. Volume pricing is available. All edges are straight cut. No custom shape options are available. VersaPRO can be imprinted with EganINK™ on 48" or 54" heights and 1 foot – 400 feet lengths.

Note: VersaPRO installation surfaces require specific surface conditions be met.

Note: continuous patterns over 9' may have design restrictions. Please contact Customer Service for further details.

■ Track & Trim

Egan offers a wide range of track and trim options to complete and surround installed VersaPro-G Wallcovering. Various Track options are available, providing the opportunity to create an Egan Wall that is tailored to your needs.

■ Markerboard | Tackboards | Shelving | Cabinets

Provide additional functionality to your Egan Wall System with Markerboards, Tackboards, Shelving and Cabinets, all designed to integrate on the Egan track system for a fluid, dynamic and multi-purpose work area.

■ VersaJOT & VersaMAG

VersaJOT and VersaMAG are perfect applications for areas that require small, non permanent labeling and signage. VersaJOT is a peel and stick EVS surface that is available in smaller dimensions for personal usage. VersaMAG is EVS applied to a magnet. It installs magnetically on any metal surface, and is offered in popular sizes or as custom shaped. VersaMAG is ideal for smaller locations where a metal surface can be upgraded for dry-erase use. EganINK™ adds branding and increases functionality.

VersaPRO® Wallcovering

Egan Visual is not responsible for installation.

Customers Own Glue (COG) installation is able to meet high expectation fit and finish when installed by a professional wallcovering specialist or qualified installer using customer's own wallcovering adhesive. The surface will be available for use after the installer supplied adhesive fully cures, typically 24 hours or as indicated by the adhesive manufacturer. This solution is recommended where the installation may be cut on site and or seamed for a wall to wall-floor to ceiling installation.

VersaPRO installation surfaces require specific installation surface conditions be met.

See installation instructions and videos online at www.egan.com. The manufacturer is not responsible for installation.

VersaPRO (VP)



Code	Description	Price	Price/ft - in addition to 10'
VP12054G	10'w x 54"h VersaPRO roll	\$900	\$90
VP12048G	10'w x 48"h VersaPRO roll	\$900	\$90

- Egan guarantees +/- 1/16" height accuracy and -0, +2" width accuracy
- See VersaPRO Crate below for higher volumes
- VersaPRO may be slit horizontally for custom applications. Contact Inside Sales for pricing. For multiple heights contact Customer Service
- Ships with two (2) assorted color Dry-Erase Markers and one (1) EganCloth

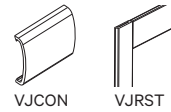
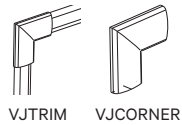

Code	Description	Price
VJTRIM96EM10	3/4" x 96" lengths of Versa Trim in EganMetallic (EM). Box of 10.	\$390
VJCORNEREM20	Versa Trim Corner pieces in EganMetallic (EM). Box of 20.	\$190
VJCONTEM20	Versa Trim Connectors pieces in EganMetallic (EM). Box of 20.	\$190
VJRST96EM	Versa Resurfacing Trim 7/16" x 96" lengths. Box of 10.	\$290
EWHTEM	60" lengths of EganSystem Track (top/bottom pair). EganMetallic (EM). Suitable for butt-joining to any length.	\$175
EWVT54	60" lengths of vertical trim (right/left pair). 11/16"w. EganMetallic (EM). Can be field cut for 48"h or 54"h installations.	\$135

- EganSystem product line can be used on trimming solutions applied on VersaPRO installed in your environment. Egan System includes double-sided markerboards and tackboards as well as an array of presentation shelves and marker tray options to enhance your presentation environment. Installing EganSystem products on top of VersaPRO multiplies presentation real estate. Egan also encourages properly installed third party framing to match the existing décor
- 96" lengths EMST also available

HOW TO ORDER

VP 120 54 G

Code Width Height Adhesive

VersaPRO-G is the choice where high expectation fit and finish is required in a floor to ceiling/wall to wall installation (note: visible seams to be expected). And must be installed exactly in position. VersaPRO-G utilizes a customer supplied wet adhesive that provides workable drying time and fitting around details like electrical fixtures.

For wallcovering fit and finish and full wall to ceiling, VersaPRO-G is offered in rolls or sheets. All edges are straight cut (factory slitting is available, custom shape options are not available).

VersaPRO can be imprinted with EganINK on heights: 48" or 54" lengths: 10 feet - 400 feet.

ACCESSORIES

400' roll freely spools material from the crate. Front edge of crate has a protective edge to reduce abrasions to the material. Self skidded for easy movement with lift truck.

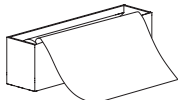

Code	Description	Dimension	Price/Ft.	Price/Roll
VPC20054	1/2 roll of VersaPRO	48"h or 54"h x 200'	\$68	\$13 600
VPC40054	1 roll of VersaPRO	48"h or 54"h x 400'	\$66	\$25 400
VPC40054	2 rolls of VersaPRO	48"h or 54"h x 400'	\$62	\$24 800
VPC40054	3+ rolls of VersaPRO	48"h or 54"h x 400'+	\$59	\$23 600

Don't Forget the Versa Caddy

The height-adjustable Versa Caddy carries the weight of a VersaPRO roll, saves on labor costs and reduces the risk of damage

Code	Description	Price
VP-CADDY	Versa Caddy	\$510

Upper Track Options

EganSystem offers track components for optimum communication flexibility and simplicity all in one product line. The discreet linear track is wall mounted at 81" high. EganSystem components are then easily suspended from the track. End caps are included. EganSystem Upper Track is designed to work with a wide variety of track mounted products including markerboards, tackboards, shelving and cabinets.

SYSTEM TRACK - ST

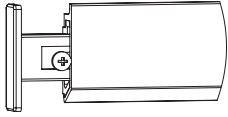

Code	Description	Dimensions	Price
EMST96	SystemTrack. Includes end caps (EMTSEC). EganMetallic (EM).	96" (8ft.) lengths	\$140
ESST96CL	SystemTrack. Includes end caps (ACTSECCL). Charcoal (CL).	96" (8ft.) lengths	\$140
ESST96PY	SystemTrack. Includes end caps (ACTSECPY). Putty (PY).	96" (8ft.) lengths	\$430
EMTSEC	End Caps for SystemTrack. 1 pair. EganMetallic (EM).		\$7
ACTSECCL	End Caps for SystemTrack. 1 pair. Charcoal (CL).		\$7
ACTSECPY	End Caps for SystemTrack. 1 pair. Putty (PY).		\$7

- Egan SystemTrack can be field cut and butt-joined to desired length

GRIP TRACK - GT

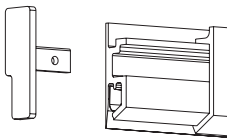

Code	Description	Dimensions	Price
EMGT96	GripTrack. Includes end caps (EMTSECG). EganMetallic (EM).	96" (8ft.) lengths	\$190
ESGT96CL	GripTrack. Includes end caps (ACTSECGCL). Charcoal (CL).	96" (8ft.) lengths	\$190
ESGT96PY	GripTrack. Includes end caps (ACTSECGPY). Putty (PY).	96" (8ft.) lengths	\$190
EMTSECG	End Caps for GripTrack. 1 pair. EganMetallic (EM).		\$30
ACTSECGCL	End Caps for GripTrack. 1 pair. Charcoal (CL).		\$30
ACTSECGPY	End Caps for GripTrack. 1 pair. Putty (PY).		\$30

- A built-in paper holder is integrated into the mounting extrusion of the track to suspend flipchart sheets directly from the track
- Specify GripTrack with EganSystem Office Shelves and Cabinets for a safe and secure installation
- Egan GripTrack can be field cut and butt-joined to desired length

TACK RAIL - ESTR

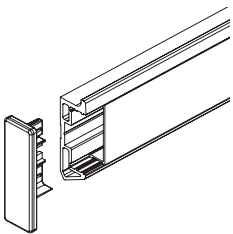

Code	Description	Infill: Tackable Material	Infill: Cork
ESTR96	96" w Tack Rail with tackable infill. Clear Anodized (CA) aluminum rail finish. 1/4" tackable strip depth. Includes end caps (ACTSECTREM).	\$210	\$210
ACTSECTREM	End Caps for Tack Rail. 1 pair. EganMetallic (EM).	\$7	

2. INFILL CASING

Code	Description
EM	EganMetallic
CL	Charcoal

INFILL OPTIONS

Code	Description
T1	Charcoal, Tackable Material
K	Natural Cork

HOW TO ORDER

ESTR 96 EM T1

1. Product Code Width 2. Infill Casing Color 3. Infill Option

Upper Track Options

Egan Tack Rail presents the opportunity to specify a tackable rail infill, permitting you to affix maps, photos, memos and more. This allows materials to be attached to the rail with the use of pins or tacks. A variety of tackable material colors are available as infill options or infill can also be installed in a convex orientation for a smooth, non-tackable finish.

TWIN TRACK - TT

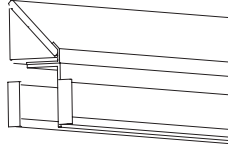

Code	Description	Dimensions	Price
EMTT120	TwinTrack. Includes end caps in EganMetallic (EM).	120" (10ft.) lengths	\$1 120
ESTT120CL	TwinTrack. Includes end caps in Charcoal (CL).	120" (10ft.) lengths	\$1 120
ESTT120PY	TwinTrack. Includes end caps in Putty (PY).	120" (10ft.) lengths	\$1 120

- One track is mounted to the wall and one additional tracks are mounted on the TwinTrack assembly
- Ships with five (5) clear, impact-resistant bumper guides that attach to the bottom frame of the boards to act as a spacer. When optional EganSystem boards are lined up in front of each other, the spacer prevents movement when using the front panel
- These products are not compatible with TwinTrack due to size restrictions: EVPR, ESR, EMTBFC, ESSH, ESOC, EMSCR, ASCRTSRPS
- Egan TwinTrack may be factory cut to specific lengths. Contact Egan Sales.

MULTI TRACK - MT

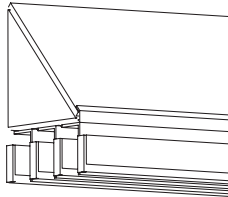

Code	Description	Dimensions	Price
EMMT120	MultiTrack. Includes end caps in EganMetallic (EM).	120" (10ft.) lengths	\$2 040
ESMT120CL	MultiTrack. Includes end caps in Charcoal (CL).	120" (10ft.) lengths	\$2 040
ESMT120PY	MultiTrack. Includes end caps in Putty (PY).	120" (10ft.) lengths	\$2 040

- One track is mounted to the wall and three additional tracks are mounted on the MultiTrack assembly
- Ships with nine (9) clear, impact-resistant bumper guides that attach to the bottom frame of the boards to act as a spacer. When optional EganSystem boards are lined up in front of each other, the spacer prevents movement when using the front panel
- These products are not compatible with MultiTrack due to size restrictions: EVPR, ESR, EMTBFC, ESSH, ESOC, EMSCR, ASCRTSRPS
- Egan MultiTrack may be factory cut to specific lengths. Contact Egan Sales.

Lower Track Options

Typically mounted at 29”h from the floor, an EganSystem Lower Track can support a variety of functional accessories. The Versa Presentation Rail (EVPR) is a handy lower-track solution designed to support presentation material including VersaBoard and EganSystem Boards, sold separately. A Reference Shelf (ESR) can be positioned at any location along the lower track to hold reference material. Also available as an **accessory to existing track installations**.

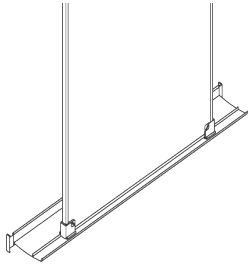

Description	Price
36”w x 5”d Presentation Rail complete with Track. Clear Anodized (CA) finish.	\$180
36”w x 5”d Presentation Rail only. Clear Anodized (CA) finish.	\$120
48”w x 5”d Presentation Rail complete with Track. Clear Anodized (CA) finish.	\$210
48”w x 5”d Presentation Rail only. Clear Anodized (CA) finish.	\$150
60”w x 5”d Presentation Rail complete with Track. Clear Anodized (CA) finish.	\$270
60”w x 5”d Presentation Rail only. Clear Anodized (CA) finish.	\$190

Custom sizes available - Select next larger size and add \$150 to list / item

1. PRODUCT CODE

Code	Description
EVPR	Versa Presentation Rail with Track
EVPK	Versa Presentation Rail only

WHAT'S IN THE BOX

Four (4) assorted color Dry-Erase Markers
One (1) EganCloth

HOW TO ORDER

EVPR 36

1. Product Code Width

Markerboards & Tackboards

EganSystem 202 track-mounted markerboards and tackboards feature unique, adjustable corner mounts that slide on and off. This design permits boards to reconfigure easily - hang them in any orientation. Finished in EganMetallic to match the 202 Collection. Available with EVS™ or EganBoard Porcelain surfaces.

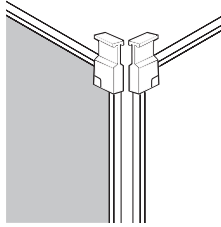
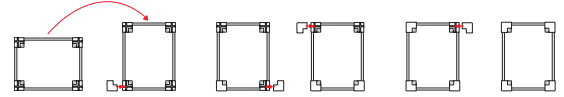

	EVS / EVS	EVS / Fabric	EVS / Grade A	EVS / Cork	Porcelain / Porcelain	Porcelain / Fabric	Porcelain / Grade A	Porcelain / Cork
26" w x 48" h	\$550	\$585	\$685	\$685	-	-	-	-
36" w x 48" h	\$690	\$765	\$875	\$875	\$790	\$815	\$980	\$980
60" w x 48" h*	\$1 070	-	-	-	-	-	-	-
26" w x 54" h	\$560	\$620	\$720	\$720	-	-	-	-
36" w x 54" h	\$720	\$890	\$890	\$890	-	-	-	-

Table indicates price for 2 sides. Eg. Side 1: EVS / Side 2: Fabric.
 *60x48 is not 2 sided and only specified with one side - EVS or Porcelain
 Custom sizes available - Select next larger size and add \$150 to list / item
 Custom Fabric Upcharge: \$150 List handling fee. Customer required to purchase fabric - COM (customer's own material).
 Price Per side | EVS and Porcelain can not be specified in a combination together | Porcelain surface is not EganINK compatible
 EVS and Porcelain are magnet compatible

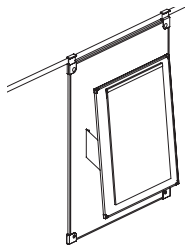

Flipchart Dimensions	EVS	Porcelain
Permanently mounted to a 36" w x 48" h	\$1 430	\$1 460

Track mounting flipchart holds a 27" w x 34" h flipchart pad. One (1) flipchart pad included

1. PRODUCT CODE

Code	Description
EETB	Markerboard EVS
EMTB	Markerboard Porcelain
EETBFC	Flipchart EVS
EMTBFC	Flipchart Porcelain

2. SURFACES

Code	Description
EE	Side 1: EVS / Side 2: EVS
EF	Side 1: EVS / Side 2: Fabric or Cork

For a full list of Standard and Grade A fabric options, visit egan.com/fabrics-and-textiles/

FINISHES

Code	Description
EM	EganMetallic
PY	Putty
CL	Charcoal

Custom Color upcharge: \$150/ product

EGANINK

Specify EganINK on EVS for a minimum upcharge of \$200 or \$25/ sqft

HOW TO ORDER

EMTB 36 48 EF I

1. Product Code Width Height 2. Surface EganINK File supplied by Egan

WHAT'S IN THE BOX

Two (2) assorted color Dry-Erase Markers
 One (1) EganCloth

Lightweight: VersaBoard

The most effective and versatile whiteboard in the world. The EVS™ surface hangs portrait or switches to landscape in seconds, with mounting options to suit every need. Incredibly lightweight, weighing as little as 3 1/2 lbs. Egan VersaBoard is reversible, offering double the work surface - and guaranteed-to-clean!

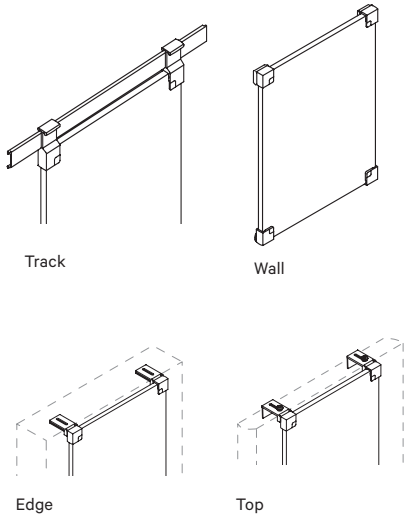
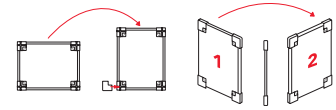

1 Board

Dimensions	Track Mount	Wall Mount	Edge Mount	Top Mount
26" w x 36" h	\$410	\$410	\$410	\$425
36" w x 48" h	\$760	\$760	\$760	\$760

3 Board Bundle - Save \$93/ Board

Dimensions	Track Mount	Wall Mount	Edge Mount	Top Mount
26" w x 36" h	\$960	\$960	\$960	\$990
36" w x 48" h	\$1 910	\$1 910	\$1 910	\$1 950

5 Board Bundle - Save \$100/ Board

Dimensions	Track Mount	Wall Mount	Edge Mount	Top Mount
26" w x 36" h	\$1 490	\$1 490	\$1 490	\$1 590
36" w x 48" h	\$2 860	\$2 860	\$2 860	\$2 970

* Track Corner Mounts are compatible with Egan Wall System boards

1. PRODUCT CODE

Code	Description
EVB	Lightweight VersaBoard

2. MOUNT

Code	Description
W	Wall Mount
E	Edge Mount
T	Track Mount
PA	Top Mount - Narrow - 2"d to 3 3/16"d
PB	Top Mount - Medium - 3 3/16"d to 4 7/16"d
PC	Top Mount - Large - 4 7/16"d to 5 5/8"d

3. QUANTITY

Code	Description
1	1 Board
3	3 Board Bundle
5	5 Board Bundle

HOW TO ORDER

EVB 36 48 PA 5 |

1. Product Code Width Height 2. Mount 3. Qty EganINK File supplied by Egan

WHAT'S IN THE BOX

Ships with specified mount
 Two (2) assorted color Dry-Erase Markers
 One (1) EganCloth

Lightweight: VersaBoard

VersaBoard ships with mounts specified. For added functionality and versatility, optional mount kits are available below.

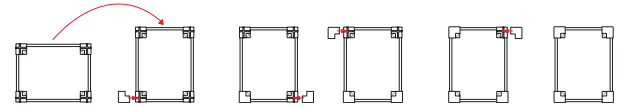

Additional VersaBoard Mount Kits

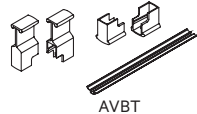
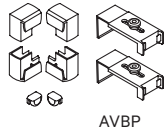
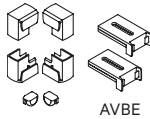
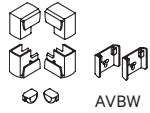

Track Mount	Dimensions	Description	Price
AVBT	N/A	Two Track corner mounts, two Track bumpers. Board not included. Compatible with Egan VersaBoards. Required for Glass (AVBG) and Magnetic Mount Kits (AVBM), wing bumper. Finished in EganMetallic (EM).	\$43

Wall Mount	Dimensions	Description	Price
AVBW	N/A	Two left and two right corner mounts, two rubber standoffs, two wall mount brackets. Restricted to 6 lb. max. weight load. VersaBoard not included. Finished in EganMetallic (EM).	\$43

Edge Mount	Dimensions	Description	Price
AVBE	N/A	Two left and two right corner mounts, two rubber standoffs, two edge mount brackets. Restricted to 6 lb. max. weight load. VersaBoard not included. Finished in EganMetallic (EM).	\$43

Top Mount	Dimensions	Description	Price
AVBPA	2" to 3 3/16"	Two left and two right corner mounts, two rubber standoffs, two Top Mount assemblies. Specify size as per code. Restricted to 6 lb. max weight load. VersaBoard not included. Finished in EganMetallic (EM).	\$66
AVBPB	3 3/16" to 4 7/16"		\$66
AVBPC	4 7/16" to 5 5/8"		\$66

VersaBoard Track Kits (EVB)

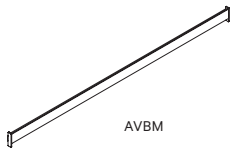
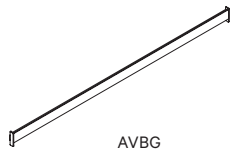

For lightweight VersaBoards only. Not compatible with EganSystem or EganSystem Office.

Adhesive-backed EganMetallic (EM) SystemTrack designed to support lightweight VersaBoards on glass windows, walls, or any smooth surface that will not accommodate a fastener. VersaBoard not included. EganSystem 202 and EganSystem Office products are too heavy for this application. For this type of installation, VersaBoard must be specified with Track Mount (AVBT) corners.

Glass Mount	Dimension	Price
AVBG37	37" lengths	\$110
AVBG49	49" lengths	\$120

Magnetic backed 37" and 49" lengths of EganMetallic (EM) SystemTrack designed to support lightweight VersaBoards on metal-surfaced panel systems, partitions or file cabinets. VersaBoard not included. EVS and EganBoard Porcelain system boards are too heavy for this application. For this type of installation, VersaBoard must be specified with Track Mount (AVBT) corners.

Magnetic Mount	Dimension	Price
AVBM37	37" lengths	\$130
AVBM49	49" lengths	\$160

Note: These two unusual track options are designed for use with lightweight Track Mount VersaBoards ONLY and are restricted to a maximum 7 lb weight load. EganSystem 202 and EganSystem Office products are too heavy for this application

Shelving

EganSystem Office Shelving is a unique track solution designed with a continuous track hanger that runs across the width of the product to evenly distribute weight to safely support the shelves and cabinets. The hanger slides easily across the track for quick, simple re-configuration. With GripTrack (GT) and EganSystem Security Locks (QB), shelves are prevented from unwanted movement.

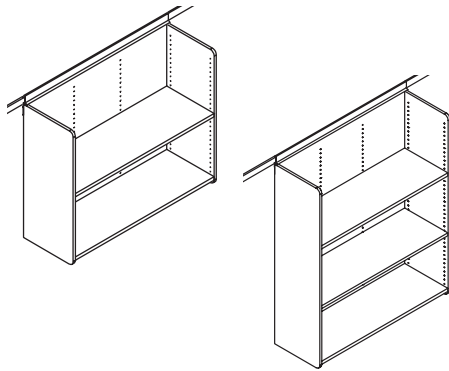

Dimensions	Price	Notes	
One fixed shelf (not shown)			
36" w x 16" h x 12 1/2" d	\$650	<ul style="list-style-type: none"> Meets California State 2001 building code, section 1632A. See below for details Shelves adjustable on 1 1/4" centers, bottom shelf fixed GripTrack required for Security Lock option. Maximum load: 60 lbs./shelf Supported from recommended 81" high SystemTrack or GripTrack Shelves can be repositioned anywhere along the track Orders for under six (6) units are shipped 'knocked-down', assembly required The optional Security Lock is a patent pending device that prevents the shelf or cabinet from lifting off the GripTrack under seismic activity. See bottom of this page for installation details 	
42" w x 16" h x 12 1/2" d	\$720		
48" w x 16" h x 12 1/2" d	\$780		
One fixed, one adjustable shelf			
36" w x 29" h x 12 1/2" d	\$870		
42" w x 29" h x 12 1/2" d	\$950		
48" w x 29" h x 12 1/2" d	\$1 010		
One fixed, two adjustable shelves			
36" w x 43" h x 12 1/2" d	\$1 020		
42" w x 43" h x 12 1/2" d	\$1 080		
48" w x 43" h x 12 1/2" d	\$1 210		

Custom sizes available - Select next larger size and add \$150 to list / item

1. PRODUCT CODE

Code	Description
ESSH	EganSystem Office Shelf

2. SHELVES

Code	Description
1	1 Fixed Shelf
2	1 Fixes, 1 Adjustable Shelf
3	1 Fixed, 2 Adjustable Shelves

3. SHELF FINISH

EganMetallic	Black	Charcoal	Gray	Platinum	Putty	Sand	Slate	Taupe
EM	BL	CL	GR	PT	PY	SN	SL	TA

HOW TO ORDER

ESSH 42 2 PT

1. Product Code Width 2. Shelves 3. Shelf Finish

SECURITY LOCK

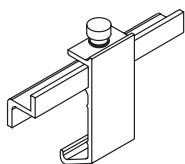

Code	Description	Price
QB	Security Locks for product security. One (1) pair.	

Egan Security Locks are designed to lock single units or a series of EganSystem Office products to the track. Great for security and to prevent shelves from lifting up and off the track. Requires GripTrack

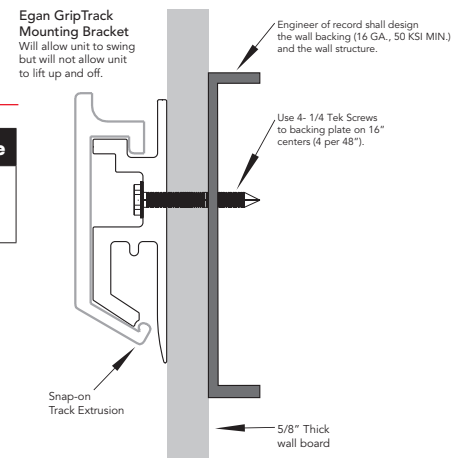

Cabinets

EganSystem Office Shelf Cabinets are designed with a continuous track hanger that runs across the width of the product to evenly distribute weight to safely support the shelves and cabinets. The hanger slides easily across the track for quick, simple re-configuration. The entire line is ideal for office environments, providing utility on the wall, without compromising floor space. With GripTrack and Security Locks, shelves are prevented from unwanted movement. 60lbs per shelf capacity.

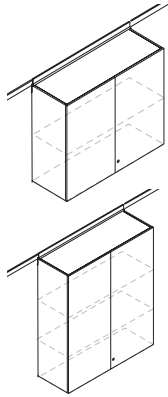

Dimensions	Etex	Wood Veneer ¹
One fixed, one adjustable shelf, two doors		
36" w x 29" h x 12 1/2" d	\$1 240	\$1 490
One fixed, two adjustable shelves, two doors		
36" w x 43" h x 12 1/2" d	\$1 450	\$1 720

Custom sizes available - Select next larger size and add \$150 to list / item

¹ Available on doors only

- Shelves adjustable on 1 1/4" centers, bottom shelf fixed. Honeycomb substrate doors have three-way adjustable hinges
- Cabinet Lock included. Key is packaged, taped to the bottom shelf of the cabinet
- Specify GripTrack with EganSystem Office for a safe and secure installation. With GripTrack (GT) and Security Lock (QB), track products will not lift up and off

EganMetallic	Black	Charcoal	Gray	Platinum	Putty	Sand	Slate	Taupe
EM	BL	CL	GR	PT	PY	SN	SL	TA

1. PRODUCT CODE

Code	Description
ESOC	EganSystem Office Cabinet

2. TOTAL SHELVES

Code	Description
2	1 Fixed Shelf
3	1 Fixes, 1 Adjustable Shelf, 2 Doors

3. FINISH

Wood Veneer Stains: Doors Only	
Code	Description
LO	Light Oak
MO	Medium Oak
DO	Dark Oak
BO	Black Oak
MA	Mahogany
CH	Cherry
MP	Natural Maple
WA	Walnut
Custom Stain (Code: CS) available Add \$250 to list, per item	

Etex Color Options: Body/ Shelf & Doors	
Code	Description
EM	EganMetallic
BL	Black
CL	Charcoal
GR	Gray
PT	Platinum
PY	Putty
SN	Sand
SL	Slate
TA	Taupe
Custom Color (Code: CC) available Add \$150 to list, per item	

HOW TO ORDER

ESOC 36 2 EM MP QB

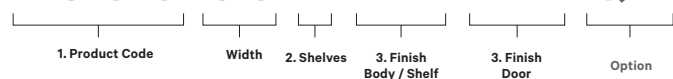

VersaJOT

Designed for quick and easy installation, this amazing pressure sensitive adhesive, dry-erase product applies to most finished surfaces in seconds. VersaJOT is offered in units precisely cut to Customer's Own Art patterns (COA). VersaJOT pieces are custom-shape, precision CNC cut from a 54" wide roll on an 84" long bed, and are applied with high-adhesive glue. Volume pricing is available.

Specifying VersaJOT

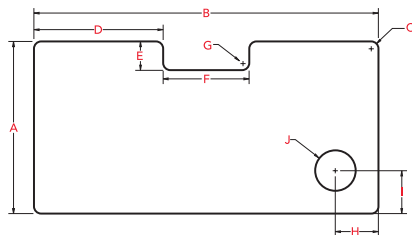

- A. Height
- B. Width
- C. Corner Radius**
- D. Notch Inset Horizontal
- E. Notch Inset Vertical
- F. Notch Width
- G. Notch Corner Radius**
- H. Knock-out Inset Horizontal
- I. Knock-out Inset Vertical
- J. Knock-out Diameter

VersaJOT is cut to your specifications for your custom requirement. Exact measurements are required.

** 1/4" radius corners are standard unless specified otherwise. Minimum radius corner is 1/8"

Egan Visual is pleased to accept COA patterns prepared in suitable vector file formats: AutoCad (DWG or DXF), Adobe Illustrator (EPS or AI), Corel Draw (EPS or CDR) to Encapsulated Postscript (EPS). Egan Visual will execute designs exactly as provided. Suitable vector files contain mathematical shapes. Embedding or "copying-and-pasting" a raster image such as a BMP, PSD, JPG, GIF, or PNG into a vector file is not suitable and will be subject to engineering charges. All VersaJOT orders are customized. Egan Visual does not accept responsibility for errors in customer instructions. Submitting a purchase order with a suitable vector file for VersaJOT release Egan Visual from responsibility for specification errors discovered upon installation.

VersaJOT (VJ)

VersaJOT is cut from a 54"w roll and is offered on a linear foot basis. For an accurate quote, call Egan Inside Sales

LFT	Price/LFT	EganINK/LFT
7-49	\$109	\$177
50-99	\$99	\$167
100+	\$87	\$155

• 7 linear feet is the minimum order size

How To Order:

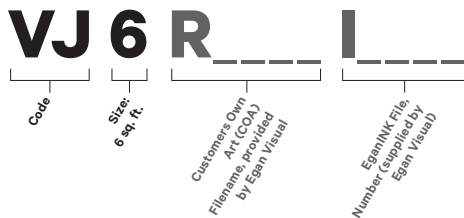

Installation Guidelines for VersaMAG and VersaJOT

A. INCORRECT



B. CORRECT



Edge Overhang:
Measure VersaMAG/ VersaJOT to inset especially on rounded corners. Example "A" will cause VersaJOT to peel off. Example "B" is a good inset from the edge.

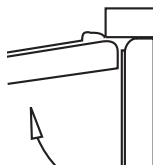

Clearance Required:
Allow for clearance on moving surfaces. The hutch door in this example does not have enough clearance (1/16"), causing an obstruction at the hinge area.

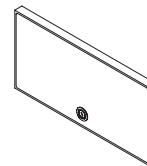

Specify VersaJOT with a 1/8" inset around edges and locks to ensure a good fit. VersaMAG is NOT available with notches or cut outs.

What's in the box:



- Ships with two (2) assorted color Dry-Erase Markers and one (1) EganCloth. Contingent upon standard size cut sheets.

Product notes:

- One knock-out shape provided at no charge. Additional knock-outs, add \$145 per sized pattern. Upcharge applies once per drawing when number of knock-outs are 2 or more on that same drawing
- Engineering charges of \$145 minimum will be applied to orders with incorrect file format
- Maximum dimensions are 54" x 84". VersaJOT has a thickness of 0.050". Minimum corner radius 1/8". Egan guarantees +/- 1/16" accuracy overall
- Square footage to be taken from gross material requirement for final pattern
- A self adhesive compact marker tray kit (VJCC) is available
- Add 1" to both Width and Height when specifying EganINK square footage

VersaMAG

VersaMAG is EVS applied to a magnet. It installs magnetically on any metal surface, and is offered in popular sizes or as custom shaped up to a maximum of 84" x 48". VersaMAG is ideal for smaller locations where a metal surface can be upgraded for dry-erase use. EganINK™ adds branding and increases functionality.

VersaMAG Run Standard (SM)

- 15" height features 1/4" eased corner detail to fit a variety of applications.



- 18" height features 1/4" eased corner detail to fit a variety of applications.



Code	Description	Price
SM2415-10	10 pieces magnetic mount 24"w x 15"h	\$550
SM2418-10	10 pieces magnetic mount 24"w x 18"h	\$660
SM3015-10	10 pieces magnetic mount 30"w x 15"h	\$770
SM3018-10	10 pieces magnetic mount 30"w x 18"h	\$870
SM3615-10	10 pieces magnetic mount 36"w x 15"h	\$730
SM3618-10	10 pieces magnetic mount 36"w x 18"h	\$890
SM4215-10	10 pieces magnetic mount 42"w x 15"h	\$1 020
SM4218-10	10 pieces magnetic mount 42"w x 18"h	\$1 190

How To Order:



* Not available in single units

VersaMAG Run Custom (VM)

VersaMAG is cut from a 48"w roll and is offered on a linear foot basis. For an accurate quote, call Egan Inside Sales.

LFT	Price/LFT	EganINK/LFT
7-49	\$117	\$185
50-99	\$104	\$172
100+	\$93	\$161

• 7 linear feet is the minimum order size

How To Order:

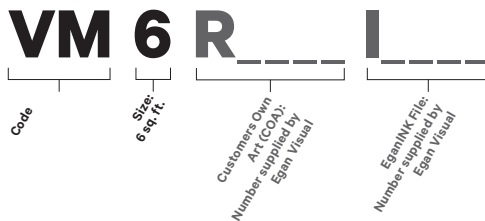

What's in the box:



- Ships with two (2) assorted color Dry-Erase Markers and one (1) EganCloth. Contingent upon standard size cut sheets.

Product notes:

- Engineering charges of \$145 minimum will be applied to orders with incorrect file format
- VersaMAG has a thickness of 0.075". Minimum corner radius 1/8". Egan guarantees ± 1/16" accuracy overall
- Square footage to be taken from gross material requirement for final pattern
- A self adhesive compact pen tray kit (VJCC) is available
- Add 1" to both Width and Height when specifying EganINK square footage
- For irregular shapes, cutouts, or notches contact Egan Inside Sales

Egan Cabinets

■ Classic Egan Etex Cabinet

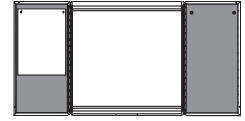

CAPX, CEXB, CABX

Choose high-performance EVS™ or EganBoard Porcelain, housed in a full featured Etex Color Cabinet. Etex coatings are impregnated with polystyrene particles, providing a very durable finish. Etex has a slight texture, hides fingerprints, and is easily maintained. Cabinet interiors are equipped with tackable EganFabric panel(s) and a flipchart with tearbar which may be suspended from either door.

■ Classic Egan Wood Cabinet

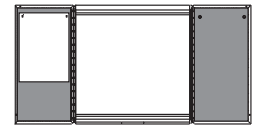

CEWR, CARW, CEWB, CABW, CEWT, CATW

Choose high-performance EVS™ surface or EganBoard Porcelain, housed in a finely crafted wood cabinet. Hand selected, solid hardwoods and veneers in the species of your choice. Face veneers are book matched and laid up to beautifully reveal the wood's best characteristics. Cabinet interiors are equipped with tackable EganFabric panel(s) and a flipchart with tearbar which may be suspended from either door.

■ Dimension Cabinet



Dimension Cabinet is a redesign of the original Presentation Cabinet that Egan Visual introduced over 40 years ago. Designed to handle modern applications like data projection, this product also meets the highest design aesthetics. Featuring EVS™ in 77" w x 48" h (16:10 format) or 60" w x 48" h and 48" w x 42" h sizes for dry-erase and projection applications. Cabinet interiors are equipped with tackable EganFabric panel(s) and a flipchart with tearbar which may be suspended from either door. Offered with Wood/Custom Stain or Etex/Custom Color doors.

■ Boxcore Cabinets



Boxcore Cabinets utilizes the VersaCabinet body and offers increased functionality and a modern design aesthetic with new front-of-cabinet surface options for additional work space, tacked notes, or even custom graphics. Door front infill can be specified in EVS™ (magnet-compatible), Tackable Fabric, GlassWrite. The body of the cabinet shows Boxcore frame, and features an EVS dry-erase guaranteed-to-clean writing surface, also magnet and projection compatible. Egan Boxcore technology brings crisp edge definition and durability, emphasizing the cabinet's clean lines and modern appearance.

Classic | Egan Etex Cabinet

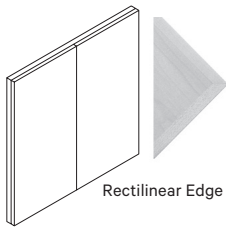

	Center Panel Porcelain	
	Interior Door Standard Fabric	Interior Door Grade A Fabric
24"w x 36"h	\$1 390	\$1 500
48"w x 32"h	\$1 930	\$2 070
48"w x 48"h	\$2 440	\$2 600
72"w x 48"h	\$3 230	\$3 420

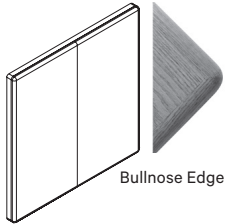

	Center Panel EVS		Center Panel Porcelain	
	Interior Door Standard Fabric	Interior Door Grade A Fabric	Interior Door Standard Fabric	Interior Door Grade A Fabric
24"w x 36"h	\$1 550	\$1 660	\$1 630	\$1 740
48"w x 32"h	\$2 290	\$2 430	\$2 430	\$2 570
48"w x 48"h	\$2 730	\$2 890	\$2 890	\$3 210
72"w x 48"h	\$3 520	\$3 710	\$3 970	\$4 160

24x36 model has only one door that mounts to open left or right | Porcelain is not EganINK Compatible Custom Fabric COM (customer's own material) Upcharge: \$150 List handling fee. Customer required to purchase fabric

1. PRODUCT CODE

Code	Description
CAPX	Rectilinear Porcelain
CEXB	Bullnose EVS
CABX	Bullnose Porcelain

3. FINISH

Code	Description
EM	EganMetallic
BL	Black
CL	Charcoal
GR	Gray
PT	Platinum
PY	Putty
SN	Sand
SL	Slate
TA	Taupe
Custom Color Add \$ 150 to list, per item	

2. SIZES

Code	Sizes
24	24"w x 36"h
32	48"w x 32"h
48	48"w x 48"h
72	72"w x 48"h

OPTIONS

Code	Option	Sizes	Price	Description
F	Flipchart	32	\$90	2nd flipchart with tearbar. The 2nd flipchart is not available on 24"w (24) cabinets.
		48	\$90	
		72	\$90	
L	Lock	ALL	\$110	Security lock.
P	Retractable Projection Screen	48	\$160	Optional for cabinets with the EVS surface. Screen ships as a standard component on cabinets with a Porcelain writing surface. Available for cabinet sizes 48 and 72 only.
		72	\$170	
D	Writing Surface Door Inserts	24	\$160	EganBoard Porcelain or EVS to match surface specified for base cabinet. Flipcharts not available with this option. Not available for Rectilinear Edge Etex Cabinet (CAPX and non-boxcore CE2). Option available only when specified on both doors.
		32	\$240	
		48	\$300	
		72	\$370	

EGAN INK

Specify EganINK on EVS for a minimum upcharge of \$200 or \$25/ sqft

WHAT'S IN THE BOX

Ships with specified mount
Four (4) assorted color Dry-Erase Markers
One (1) EganCloth

HOW TO ORDER

CEXB 48 EM LF I _____

1. Product Code 2. Size 3. Finish Option EganINK

Classic | Egan Wood Cabinet

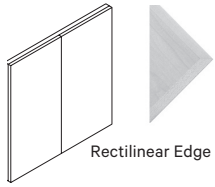

	EVS Center Panel		Porcelain Center Panel	
	Tack Panel Standard Fabric	Tack Panel Grade A	Tack Panel Standard Fabric	Tack Panel Grade A
24"w x 36"h	\$1 660	\$1 770	\$1 780	\$1 890
48"w x 32"h	\$2 430	\$2 570	\$2 510	\$2 650
48"w x 48"h	\$3 040	\$3 200	\$3 350	\$3 510
72"w x 48"h	\$3 890	\$4 080	\$4 280	\$4 470

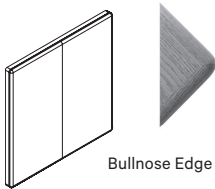

	EVS Center Panel		Porcelain Center Panel	
	Tack Panel Standard Fabric	Tack Panel Grade A	Tack Panel Standard Fabric	Tack Panel Grade A
24"w x 36"h	\$1 780	\$1 890	\$1 820	\$1 930
48"w x 32"h	\$2 840	\$2 980	\$2 950	\$3 090
48"w x 48"h	\$3 290	\$3 450	\$3 770	\$3 930
72"w x 48"h	\$4 230	\$4 420	\$4 580	\$4 770

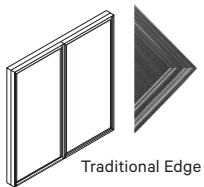

	EVS Center Panel		Porcelain Center Panel	
	Tack Panel Standard Fabric	Tack Panel Grade A	Tack Panel Standard Fabric	Tack Panel Grade A
24"w x 36"h	\$1 890	\$2 000	\$1 980	\$2 090
48"w x 32"h	\$2 970	\$3 110	\$3 120	\$3 260
48"w x 48"h	\$3 480	\$3 640	\$3 810	\$3 970
72"w x 48"h	\$4 570	\$4 760	\$4 970	\$5 160

1. PRODUCT CODE

Code	Description
CEWR	Rectilinear EVS
CARW	Rectilinear Porcelain
CEWB	Bullnose EVS
CABW	Bullnose Porcelain
CEWT	Traditional EVS
CATW	Traditional Porcelain

3. FINISH

Code	Description
LO	Light Oak
MO	Medium Oak
DO	Dark Oak
BO	Black Oak
MA	Mahogany
CH	Cherry
MP	Natural Maple
WA	Walnut

Custom Stain available. Add \$250 to list, per item.

2. SIZES

Code	Sizes
24	24"w x 36"h
32	48"w x 32"h
48	48"w x 48"h
72	72"w x 48"h

Classic | Egan Wood Cabinet

OPTIONS

Code	Option	Sizes	Price	Description
F	Flipchart	32 48 72	\$90	2nd flipchart with tearbar. The 2nd flipchart is not available on 24"w cabinets.
L	Lock	ALL	\$110	Security lock.
B or S	Inlay 	24 32 48 72	\$330 \$660 \$710 \$770	Brass (B) or Steel (S) inlays. Available on cabinets with Rectilinear or Bullnose Edge detail only. Not available for cabinets with Traditional Edge detail. Inlay is mounted flush with the veneer surface, between the veneer panel and the hardwood molding on both doors.
P	Retractable Projection Screen	48 72	\$160 \$170	Optional for cabinets with the EVS surface. Screen ships as a standard component on cabinets with a Porcelain writing surface. Available for cabinet sizes 48"w and 72"w only.
D	Writing Surface Door Inserts	24 32 48 72	\$160 \$250 \$300 \$370	EganBoard Porcelain or EVS to match surface specified for base cabinet. Flipcharts not available with this option. Not available for Rectilinear Edge Etex Cabinet (CAPX and non-boxcore CE2). Option available only when specified on both doors.
Custom Logo			Inquire*	

HOW TO ORDER

CEWB 48 CH LF

1. Product Code

2. Size

3. Finish

Option

Dimension Cabinet

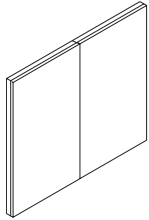

	Door Etex		Door Wood Veneer	
	Interior Door Standard Fabric	Interior Door Grade A Fabric	Interior Door Standard Fabric	Interior Door Grade A Fabric
48"w x 42"h	\$1 990	\$2 150	\$2 780	\$2 940
60"w x 48"h	\$2 210	\$2 390	\$3 080	\$3 260
77"w x 48"h	\$2 830	\$3 025	\$3 740	\$3 940

* Optimized for projection aspect ratio | Interior Doors: Cork and EVS not available
 COM (customer's own material) Upcharge: \$150 List handling fee. Customer required to purchase fabric
 24x36 model has only one door that mounts to open left or right

1. PRODUCT CODE

Code	Description
CE2	Dimension Cabinet EVS

2. BODY FINISH

Code	Description
A	Clear Anodized
B	Black Anodized

3. DOOR FINISH

Etex Color Options: Doors Only	
Code	Description
EM	EganMetallic
BL	Black
CL	Charcoal
GR	Gray
PT	Platinum
PY	Putty
SN	Sand
SL	Slate
TA	Taupe
Custom Color available Add \$150 to list, per item	

Wood Veneer Stains: Doors Only	
Code	Description
LO	Light Oak
MO	Medium Oak
DO	Dark Oak
GO	Gray Oak
BO	Black Oak
MA	Mahogany
CH	Cherry
MP	Natural Maple
WA	Walnut
Custom Stain available Add \$250 to list, per item	

OPTIONS

Code	Description	Price
F	2nd Flipchart with TearBar	\$85
L	Keyed Security Lock	\$100
FL	TearBar and Keyed Security Lock	\$185

EGAN INK

Specify EganINK on EVS for a minimum upcharge of \$200 or \$25/ sqft

WHAT'S IN THE BOX

Ships with specified mount
 Four (4) assorted color Dry-Erase Markers
 One (1) EganCloth

HOW TO ORDER

CE2 A 60 48 MP FL 463490-001 I

1. Product Code 2. Body Finish Width Height 3. Door Finish Option Fabric EganINK

For a full list of Standard and Grade A fabric options, see page 88 or visit egan.com

Boxcore Cabinet

Dimensions	EVS	GlassWriteMAG	Tack EcoTack	Tack Standard Fabric	Tack Grade A Fabric
24" w x 36" h x 3" d	\$1 280	\$1 810	\$1 350	\$1 410	\$1 510
48" w x 42" h x 3" d	\$2 460	\$3 130	\$2 590	\$2 710	\$2 840
60" w x 48" h x 3" d	\$2 570	\$4 310	\$2 890	\$3 030	\$3 180
77" w x 48" h x 3" d	\$3 150	\$5 020	\$3 310	\$3 470	\$3 650

COM (customer's own material) Upcharge: \$150 List handling fee. Customer required to purchase fabric Door finish for EVS and custom color.
 24x36 model has only one door that mounts to open left or right
 Magnet Compatible

1. PRODUCT CODE

Code	Description
CEEB	Boxcore EVS
CEEB	Boxcore Tack
CEGMB	GlassWrite Glass

2. BODY FINISH

Code	Description
A	Clear Anodized

3. DOOR FINISH

Door Front

Code	Description	
E	EVS	
F	Fabric	For a full list of Standard and Grade A fabric options, visit egan.com/fabrics-and-textiles/
IP	Glass Infinite Color Program	Visit egan.com or pantone.com for colors.
CC	Custom Color	

Door Interior

Code	Description
E	EVS

EGAN INK

Specify EganINK on EVS or GlassWrite for a minimum upcharge of \$200 or \$25/ sqft

HOW TO ORDER

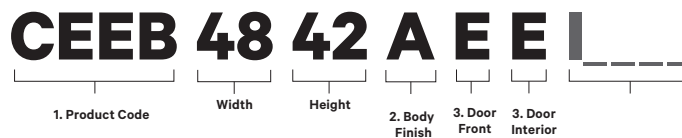

WHAT'S IN THE BOX

Ships with specified mount
 Four (4) assorted color Dry-Erase Markers
 One (1) EganCloth

Egan Mobiles

■ Architrave Mobile

Architrave products are defined by their sturdy, wood oak Boxcore 1 1/8" (29mm) frame. Features of the Architrave family consist of thin bezel edge of 1/4" (6mm), a robust construction with a clean external appearance and no extraneous materials. Specify Architrave mobile from a range of infill options, such as EVS, GlassWrite, EganINK, Tackable fabric or EcoTack/Polyethylene Terephthalate (PET).

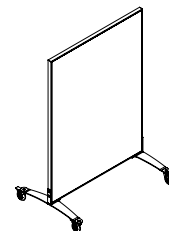

■ Boxcore Mobile

The Boxcore Mobile utilizes the unique Egan Boxcore™ design for a high degree of stability when moving and when writing. It is distinguished by an ultra-thin bezel, and aluminum frame in 1 1/8" (29mm) depth. The Boxcore Mobile has a new frame to base connection, for clean uninterrupted lines. This new connection provides additional functionality by linking together multiple Boxcore Mobiles on a linear plane with only a 1/4 gap between mobiles. Available with EVS, Glass and Tackable infills.

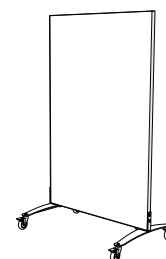

■ V-Series Mobile

V-Series Mobiles are available with Four-Point Base and Three-Point Bases. The V-Series Four-Point Base Mobiles are designed to link or stand alone, whereas, the Three-Point Base Mobiles are designed to work with Four-Point base models to create linked partitions that can be positioned at almost any angle. These Mobiles feature guaranteed-to-clean EVS™ dry-erase surface that accepts magnetic accessories. Three-Point Base models are not recommended for non-linked applications.

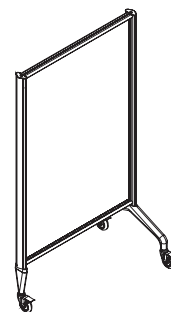

■ Egan Lite Mobile

Egan Lite Mobiles are incredibly lightweight and easy to move, base options include locking casters or a low profile bases to suit your application. The Lite Mobile is also available as a Screen Door - a weighted trip-free base with exceptional stability and rotation through 360°. A 90° notch in the base provides compatibility with any wall or partition system. The no-lock front caster rolls smoothly and ensures door will fold back to permit free traffic flow. Egan Lite Mobiles can be specified with an EVS or Tackable infill per side.

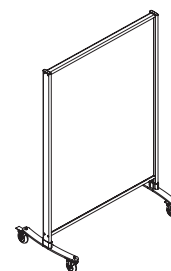

■ A-Frame VersaMobile

A-Frame VersaMobiles offer two-sided high-performance EVS™ dry-erase surface. Specify any combination of EVS™ magnetic surface or Egan tackable fabric. A fixed track at the top of the A-Frame accommodates lightweight VersaBoards or EganSystem Track boards. Additional VersaBoards or 202 EganSystem Boards sold separately. Storage for up to five boards is available inside the spacious A-Frame shelf cavity.



Architrave Mobile

Architrave products are defined by their sturdy, wood oak Boxcore 1 1/8" (29mm) frame. Features of the Architrave family consist of thin bezel edge of 1/4" (6mm), a robust construction with a clean external appearance and no extraneous materials. Specify your Architrave mobile from a range of infill options, such as EVS, GlassWrite, EganINK, Tackable fabric (EganFabric or maharam), or EcoTack.

Architrave Mobiles can be specified with a different infill per side. Pricing reflects costs for 1 side only. Choose an infill for each side and add the price together for the total cost. If the infill is the same for both sides, simply double the cost in the chart below.

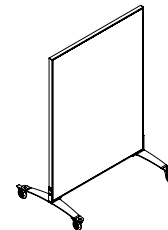

Table Shows Pricing Per Side of Board

Dimensions	EVS/ per side	Tack EcoTack/ per side	Tack Standard Fabric/ per side	Tack Grade A Fabric/ per side
36"w x 54"h x 23 1/2"d	\$1 060	\$1 115	\$1 165	\$1 225
48"w x 54"h x 23 1/2"d	\$1 225	\$1 290	\$1 345	\$1 420
36"w x 60"h x 23 1/2"d	\$1 110	\$1 165	\$1 220	\$1 280
48"w x 60"h x 23 1/2"d	\$1 260	\$1 325	\$1 385	\$1 455
36"w x 72"h x 23 1/2"d	\$1 295	\$1 360	\$1 425	\$1 485
48"w x 72"h x 23 1/2"d	\$1 310	\$1 375	\$1 440	\$1 510

Table indicates price per side of mobile. ie. Cost of single side EVS is \$1060, and 2 sided EVS is \$2120
 Custom sizes available - Select next larger size and add \$150 to list / item
 COM (customer's own material) Upcharge: \$150 List handling fee. Customer required to purchase fabric

PRODUCT CODE

Code	Description
ARCM	EVS, EcoTack or Fabric

2. SURFACE

Code	Description
E	EVS
T	EcoTack/PET
F	Fabric

For a full list of Standard and Grade A fabric options, visit egan.com/fabrics-and-textiles/

3. FRAME STAINS

Code	Description	Price
LO	Light Oak	\$ 0
MO	Medium Oak	\$ 0
DO	Dark Oak	\$ 0
BO	Black Oak	\$ 0
CS	Custom Stain	\$ 250

4. BASE COLOR

Code	Description	Price
WH	White	\$ 0
EM	EganMetallic	\$ 0
CC	Custom Color	\$ 150

EGANINK

Specify EganINK on EVS or Glass for a minimum upcharge of \$200 or \$25/sf

HOW TO ORDER

ARCM	36	66	E	E	MO	WH	I
1. Product Code	Width	Height	2. Surface Side 1	Side 2	3. Frame Stains	4. Base Color	EganINK #

WHAT'S IN THE BOX

Two (2) assorted color Dry-Erase Markers
 One (1) EganCloth

Architrave Mobile GlassWrite

Architrave products are defined by their sturdy, wood oak Boxcore 1 1/8" (29mm) frame. Features of the Architrave family consist of thin bezel edge of 1/4" (6mm), a robust construction with a clean external appearance and no extraneous materials. Architrave mobile can be specified with GlassWrite infill on both sides.

Egan GlassWrite is built from a guaranteed-to-clean, crystal clear, low iron tempered safety glass. GlassWrite surfaces are dry erase, guaranteed-to-clean board, neo-magnet compatible, and with color from Egan's infinite color program or high-resolution printing with EganINK.

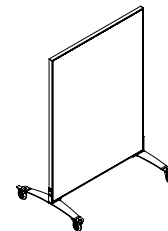

Dimensions	GlassWrite MAG
36"w x 54"h x 23 1/2"d	\$3 930
48"w x 54"h x 23 1/2"d	\$4 990
36"w x 60"h x 23 1/2"d	\$4 120
48"w x 60"h x 23 1/2"d	\$5 120
36"w x 72"h x 23 1/2"d	\$4 840
48"w x 72"h x 23 1/2"d	\$5 810

GlassWrite MAG cannot be specified with other infills.

Custom sizes available - Select next larger size and add \$150 to list / item

1. PRODUCT CODE

Code	Description
ARCM	GlassWrite MAG

2. SURFACE

Code	Description
GG	GlassWrite (double sided only)
For a full list of Standard and Grade A fabric options, visit egan.com/fabrics-and-textiles/	

2. GLASS COLOR

Code	Description	Price
WH	White	\$ 0
IP	Infinite Program	\$ 0
CC	Custom Color	\$ 150
Visit egan.com or pantone.com for colors.		

3. FRAME STAINS

Code	Description	Price
LO	Light Oak	\$ 0
MO	Medium Oak	\$ 0
DO	Dark Oak	\$ 0
BO	Black Oak	\$ 0
CS	Custom Stain	\$ 250

4. BASE COLOR

Code	Description	Price
WH	White	\$ 0
EM	EganMetallic	\$ 0
CC	Custom Color	\$ 150

EGANINK

Specify EganINK on EVS or Glass for a minimum upcharge of \$200 or \$25/sf

HOW TO ORDER

ARCM	36	66	G	G	WH	MO	WH	I	_____
1. Product Code	Width	Height	2. Surface Side 1 Side 2		3. Glass Color	4. Frame Stains	5. Base Color	EganINK #	

WHAT'S IN THE BOX

Two (2) assorted color Dry-Erase Markers
One (1) EganCloth

Boxcore Mobile

The Boxcore Mobile utilizes the unique Egan Boxcore™ design for a high degree of stability when moving and when writing. It is distinguished by an ultra-thin bezel, and a powdercoated white aluminum frame in 1 1/8" (29mm) depth, The Boxcore Mobile has a new frame to base connection, for clean uninterrupted lines. This new connection provides additional functionality by linking together multiple Boxcore Mobiles on a linear plane with only a 1/4 gap between mobiles. Available with EVS, Glass and Tackable infills.

Boxcore Mobiles can be specified with a different infill per side. Pricing reflects costs for 1 side only. Choose an infill for each side and add the price together for the total cost. If the infill is the same for both sides, simply double the cost in the chart below.

Table Shows Pricing Per Side of Board

Dimensions	EVS/ per side	Tack EcoTack/ per side	Tack Standard Fabric/ per side	Tack Grade A Fabric/ per side
36"w x 54"h x 23 1/2"d	\$1 060	\$1 115	\$1 165	\$1 225
48"w x 54"h x 23 1/2"d	\$1 225	\$1 290	\$1 345	\$1 420
36"w x 60"h x 23 1/2"d	\$1 110	\$1 165	\$1 220	\$1 280
48"w x 60"h x 23 1/2"d	\$1 260	\$1 325	\$1 385	\$1 455
36"w x 72"h x 23 1/2"d	\$1 295	\$1 360	\$1 425	\$1 485
48"w x 72"h x 23 1/2"d	\$1 310	\$1 375	\$1 440	\$1 510

Table indicates price per side of mobile. ie. Cost of single side EVS is \$1060, and 2 sided EVS is \$2120
 Custom sizes available - Select next larger size and add \$150 to list / item
 COM (customer's own material) Upcharge: \$150 List handling fee. Customer required to purchase fabric

1. PRODUCT CODE

Code	Description
VBD	EVS, Fabric, or EcoTack

2. SURFACE

Code	Description
E	EVS
F	Fabric
T	EcoTack/PET

For a full list of Standard and Grade A fabric options, visit egan.com/fabrics-and-textiles/

3. FRAME

Code	Description	Price
WH	White	\$ 0
CA	Clear Anodized	\$ 0
CC	Custom Color	\$ 150

4. BASE

Code	Description	Price
WH	White	\$ 0
EM	EganMetallic	\$ 0
CC	Custom Color	\$ 150

EGANINK

Specify EganINK on EVS or Glass for a minimum upcharge of \$200 or \$25/sf

HOW TO ORDER

VBD 36 60 E F WH WH I

1. Product Code Width Height 2. Surface Side 1 Side 2 3. Frame Color 3. Base Color EganINK #

WHAT'S IN THE BOX

Two (2) assorted color Dry-Erase Markers
 One (1) EganCloth

Boxcore Mobile GlassWrite

The Boxcore Mobile utilizes the unique Egan Boxcore™ design for a high degree of stability when moving and when writing. It is distinguished by an ultra-thin bezel, and aluminum frame in 1 1/8" (29mm) depth. The Boxcore Mobile has a frame to base connection, for clean uninterrupted lines. The Boxcore Mobile GlassWrite is built from a guaranteed-to-clean, crystal clear, low iron tempered safety glass for high clarity of surface. GlassWrite is neo-magent compatible and is available with Egan Infinite Palette - choose from 1,050 standard glass colors.

Dimensions	GlassWrite MAG
36" w x 54" h x 23 1/2" d	\$3 930
48" w x 54" h x 23 1/2" d	\$4 990
36" w x 60" h x 23 1/2" d	\$4 120
48" w x 60" h x 23 1/2" d	\$5 120
36" w x 72" h x 23 1/2" d	\$4 840
48" w x 72" h x 23 1/2" d	\$5 810

GlassWrite MAG cannot be specified with other infills. Use product code VBM to specify two side glass mobile.
 Custom sizes available - Select next larger size and add \$150 to list / item

Mobiles

1. PRODUCT CODE

Code	Description
VBM	GlassWrite MAG

EGANINK

Specify EganINK on EVS or Glass for a minimum upcharge of \$200 or \$25/sf

2. GLASS COLOR

Code	Description	Price
WH	White	\$ 0
IP	Infinite Color Program	\$ 0
CC	Custom Color	\$ 150

Visit egan.com or pantone.com for colors.

3. FRAME

Code	Description	Price
WH	White	\$ 0
CA	Clear Anodized	\$ 0
CC	Custom Color	\$ 150

4. BASE

Code	Description	Price
WH	White	\$ 0
EM	EganMetallic	\$ 0
CC	Custom Color	\$ 150

HOW TO ORDER



WHAT'S IN THE BOX

Two (2) assorted color Dry-Erase Markers
 One (1) EganCloth

V-Series Mobile

Table Shows Pricing Per Side of Board

Dimensions	4 Point Base - VSF				3 Point Base - VST			
	EVS/ per side	Standard Fabric/ per side	Grade A Fabric/ per side	Cork/ per side	EVS/ per side	Standard Fabric/ per side	Grade A Fabric/ per side	Cork/ per side
36" w x 54" h x 20" d	\$790	\$870	\$985	\$985	\$765	\$840	\$960	\$960
48" w x 54" h x 20" d	\$835	\$920	\$1 055	\$1 055	\$810	\$890	\$1 010	\$1 010
36" w x 60" h x 20" d	\$845	\$930	\$1 050	\$1 050	\$820	\$900	\$1 020	\$1 020
48" w x 60" h x 20" d	\$895	\$985	\$1 120	\$1 120	\$870	\$960	\$1 090	\$1 090
36" w x 72" h x 20" d	\$895	\$985	\$1 100	\$1 100	-	-	-	-
48" w x 72" h x 20" d	\$945	\$1 040	\$1 175	\$1 175	-	-	-	-

Projection Compatible

60" w x 72" h x 20" d \$2 490

Table indicates price per side of mobile. ie. Cost of single side EVS is \$790, and 2 sided EVS is \$1580

V-Series Projection (VPF) - available with EVS on both sides. Upper Panel EVS surface - 58 1/2" w x 47 3/4" h and Lower Panel perforated metal (EM) 58 1/2" w x 12 3/4" h.

1. PRODUCT CODE

Custom sizes available -
Select next larger size and
add \$150 to list / item

Code	Description
VSF	V-Series 4pt
VST	V-Series 3pt
VPF	V-Series 4pt Projection Mobile

2. SURFACE

*Custom Fabric Upcharge:
\$150 List handling fee.
Customer required to
purchase fabric - COM
(customer's own material)

Code	Description
E	EVS
F	Fabric
K	Cork

For a full list of Standard and Grade A fabric options, visit egan.com/fabrics-and-textiles/

3. FRAME

Code	Description	Price
WH	White	\$ 0
CA	Clear Anodized	\$ 0
CC	Custom Color	\$ 150

4. BASE

Code	Description	Price
WH	White	\$ 0
EM	EganMetallic	\$ 0
CC	Custom Color	\$ 150

EGANINK

Specify EganINK on EVS for a minimum upcharge of \$200 or \$25/ sqft

WHAT'S IN THE BOX

Two (2) assorted color Dry-Erase Markers
One (1) EganCloth

ACCESSORIES

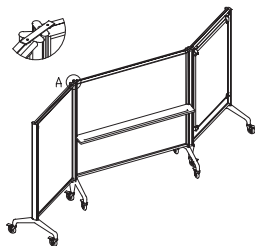

All V-Series Options are finished in EganMetallic (EM).

Code	Description	Price
L	Link Option. Factory installed. Includes one Link Connector and two Vertical Bumpers.	\$85
AVBM27.5	Magnetic Track Kit - 27 1/2" w track for mobiles 30" w or more. 6 lb. capacity.	\$115
AVBM33.5	Magnetic Track Kit - 33 1/2" w track for mobiles 36" w or more. 6 lb. capacity.	\$120
AVBM45.5	Magnetic Track Kit - 45 1/2" w track for mobiles 48" w or more. 6 lb. capacity.	\$145
AVBM57.5	Magnetic Track Kit - 57 1/2" w track for mobiles 60" w or more. 6 lb. capacity.	\$175
ACBUMPER	Upgrade Kit, which includes PVC Protective Bumpers and Link Connectors.	\$120
ACLINK	Additional Single Link Connectors.	\$65
ACSHELF30	Accessory Shelf - 30" w x 1" h x 5" d. Available for VCF, VSF, VGS, VGC, and VGM.	\$195
ACSHELF36	Accessory Shelf - 36" w x 1" h x 5" d. Available for VCF, VSF, VGS, VGC, and VGM.	\$200
ACSHELF42	Accessory Shelf - 42" w x 1" h x 5" d. Available for VGS, VGC, and VGM.	\$205
ACSHELF48	Accessory Shelf - 48" w x 1" h x 5" d. Available for VCF, VSF, VGS, VGC, and VGM.	\$205
ACSHELF60	Accessory Shelf - 60" w x 1" h x 5" d. Available for VCF, VSF, VGS, VGC, VGM and VPF.	\$210

HOW TO ORDER

VST 36 54 E F L

1. Product Code Width Height 2. Surface Options
Side 1 Side 2

V-Series Mobile | Split Panel

These Mobiles have increased utility with a 18 11/16" high tackable panel at the bottom. The upper panel can be specified with EVS or Tackable infill. Pricing below assumes Standard Fabric on lower panel. V-Series Mobiles (VCF and VCT) can be specified with an EVS or Tackable infill per side. Pricing reflects costs for 1 side only. Choose an infill for each side and add the price together for the total cost. If the infill is the same for both sides, simply double the cost in the chart below. Pricing includes Standard Fabric on lower panel, to upgrade to Grade A Fabric, simply add the cost in the chart below of the upgrade to your total cost.

Table Shows Pricing Per Side of Board

Dimensions	4 Point Base - VCF					3 Point Base - VCT				
	EVS/ per side	Standard Fabric/ per side	Grade A Fabric/ per side	Cork/ per side	Upgrade Lower Panel/ per side	EVS/ per side	Standard Fabric/ per side	Grade A Fabric/ per side	Cork/ per side	Upgrade Lower Panel/ per side
36" w x 54" h x 20" d	\$810	\$890	\$1 010	\$1 010	\$155	\$790	\$870	\$970	\$970	\$155
48" w x 54" h x 20" d	\$860	\$950	\$1 080	\$1 080	\$175	\$835	\$920	\$1 040	\$1 040	\$175
36" w x 60" h x 20" d	\$880	\$970	\$1 085	\$1 085	\$155	\$860	\$950	\$1 060	\$1 060	\$155
48" w x 60" h x 20" d	\$920	\$1 015	\$1 150	\$1 150	\$175	\$895	\$985	\$1 120	\$1 120	\$175
36" w x 72" h x 20" d	\$920	\$1 015	\$1 120	\$1 120	\$155	-	-	-	-	-
48" w x 72" h x 20" d	\$975	\$1 075	\$1 210	\$1 210	\$175	-	-	-	-	-

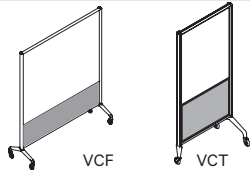

Custom sizes available - Select next larger size and add \$150 to list / item
 Table indicates price per side of mobile. ie. Cost of single side EVS is \$810, and 2 sided EVS is \$1620
 COM (customer's own material) Upcharge: \$150 List handling fee. Customer required to purchase fabric
 Lower Panel Height: 18 11/16"

1. PRODUCT CODE

Code	Description
VCF	V-Series 4pt Split Panel
VCT	V-Series 3pt Split Panel

2. SURFACE

Code	Description
E	EVS
F	Fabric
K	Cork

For a full list of Standard and Grade A fabric options, visit egan.com/fabrics-and-textiles/

EGANINK

Specify EganINK on EVS for a minimum upcharge of \$200 or \$25/ sqft

WHAT'S IN THE BOX

Two (2) assorted color Dry-Erase Markers
 One (1) EganCloth

ACCESSORIES

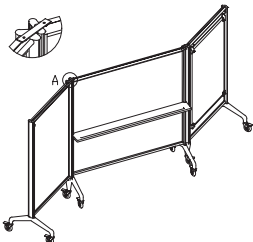

All V-Series Options are finished in EganMetallic (EM).

Code	Description	Price
L	Link Option. Factory installed. Includes one Link Connector and two Vertical Bumpers.	\$85
AVBM27.5	Magnetic Track Kit - 27 1/2" w track for mobiles 30" w or more. 6 lb. capacity.	\$115
AVBM33.5	Magnetic Track Kit - 33 1/2" w track for mobiles 36" w or more. 6 lb. capacity.	\$120
AVBM45.5	Magnetic Track Kit - 45 1/2" w track for mobiles 48" w or more. 6 lb. capacity.	\$145
AVBM57.5	Magnetic Track Kit - 57 1/2" w track for mobiles 60" w or more. 6 lb. capacity.	\$175
ACBUMPER	Upgrade Kit, which includes PVC Protective Bumpers and Link Connectors.	\$120
ACLINK	Additional Single Link Connectors.	\$65
ACSHELF30	Accessory Shelf - 30" w x 1" h x 5" d. Available for VCF, VSF, VGS, VGC, and VGM.	\$195
ACSHELF36	Accessory Shelf - 36" w x 1" h x 5" d. Available for VCF, VSF, VGS, VGC, and VGM.	\$200
ACSHELF42	Accessory Shelf - 42" w x 1" h x 5" d. Available for VGS, VGC, and VGM.	\$205
ACSHELF48	Accessory Shelf - 48" w x 1" h x 5" d. Available for VCF, VSF, VGS, VGC, and VGM.	\$205
ACSHELF60	Accessory Shelf - 60" w x 1" h x 5" d. Available for VCF, VSF, VGS, VGC, VGM and VPF.	\$210

HOW TO ORDER

VCT 36 54 E F L

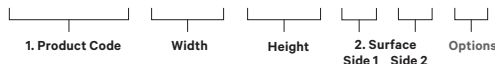

V-Series GlassWrite™ Mobile

GlassWrite™ Mobiles enliven open areas while creating privacy, and enhancing the natural light. Egan V-Series Mobiles may be specified with translucent frosted GlassWrite panels or GlassWrite MAG available in 1,050 standard colors. V-Series Mobiles feature Egan GlassWrite low iron tempered glass panels offered full height or split height with Tackable infills. Designed to link or stand alone - see other V-Series Mobiles and V-Series Options. GlassWrite MAG is magnet compatible. V-Series GlassWrite and GlassWrite MAG can be specified with a one infill/ material only. Pricing reflects costs for both sides.

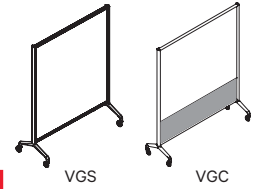

Table Shows Pricing Both Sides of Board

Dimensions	SINGLE PANE			SPLIT PANE - GLASSWRITE TOP & TACKABLE BOTTOM		
	Clear	Frosted	GlassWrite MAG	Frosted Standard Fabric	Frosted Grade A Fabric	Frosted Cork
36" w x 54" h x 20" d	\$1 780	\$1 780	\$1 810	\$1 830	\$1 980	\$1 980
48" w x 54" h x 20" d	\$1 870	\$1 870	\$1 930	\$1 920	\$2 050	\$2 050
36" w x 60" h x 20" d	\$1 890	\$1 890	\$1 930	\$1 950	\$2 095	\$2 095
48" w x 60" h x 20" d	\$1 990	\$1 990	\$2 050	\$2 040	\$2 205	\$2 205
36" w x 72" h x 20" d	\$2 110	\$2 110	\$2 195	\$2 165	\$2 335	\$2 335
48" w x 72" h x 20" d	\$2 225	\$2 225	\$2 295	\$2 280	\$2 470	\$2 470

*Lower Panel Tackable Fabric or Cork - Height: 18 11/16"

Table indicates price 2 sides of mobile.

Custom sizes available - Select next larger size and add \$150 to list / item

COM (customer's own material) Upcharge: \$150 List handling fee. Customer required to purchase fabric

1. PRODUCT CODE

Code	Description
VGS	V-Series GlassWrite Clear & Frosted
VGM	V-Series GlassWrite MAG
VGC	V-Series GlassWrite Frosted Split Panel
VGM-SS	V-Series GlassWrite MAG Split Panel

2. GLASS COLOR

Code	Description	Price
WH	White	\$ 0
IP	Infinite Program	\$ 0
CC	Custom Color	\$ 150

Visit egan.com or pantone.com for colors.

FABRIC

For a full list of Standard and Grade A fabric options, visit egan.com/fabrics-and-textiles/

EGANINK

Specify EganINK on glass for a minimum upcharge of \$200 or \$25/ sqft

ACCESSORIES

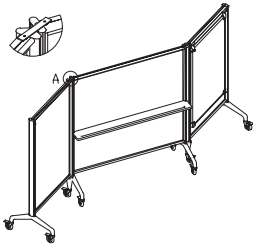

Code	Description	Price
L	Link Option. Factory installed. Includes one Link Connector and two Vertical Bumpers.	\$85
ACLINK	Additional Single Link Connectors.	\$65
ACSHELF30	Accessory Shelf - 30" w x 1" h x 5" d. Available for VCF, VSF, VGS, VGC, and VGM.	\$195
ACSHELF36	Accessory Shelf - 36" w x 1" h x 5" d. Available for VCF, VSF, VGS, VGC, and VGM.	\$200
ACSHELF48	Accessory Shelf - 48" w x 1" h x 5" d. Available for VCF, VSF, VGS, VGC, and VGM.	\$205
ACSHELF60	Accessory Shelf - 60" w x 1" h x 5" d. Available for VCF, VSF, VGS, VGC, VGM and VPF.	\$210
ACSHELF42	Accessory Shelf - 42" w x 1" h x 5" d. Available for VGS, VGC, and VGM.	\$205

*All V-Series accessories are finished in EganMetallic (EM).

HOW TO ORDER



WHAT'S IN THE BOX

Two (2) assorted color Dry-Erase Markers
 One (1) EganCloth

Egan Lite Mobile & Screen Door

Egan Lite Mobiles are incredibly lightweight and easy to move, base options include locking casters or a low profile bases to suit your application. Egan Lite Mobiles can be specified with an EVS or Tackable infill per side.

Pricing reflects costs for 1 side only. Choose an infill for each side and add the price together for the total cost. If the infill is the same for both sides, simply double the cost in the chart below.

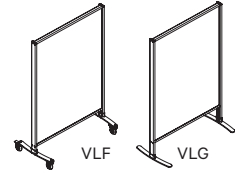

Table Shows Pricing Per Side of Board

Dimensions	CASTER BASE				GLIDE BASE			
	EVS	Tack Standard Fabric	Tack Grade A Fabric	Tack Cork	EVS	Tack Standard Fabric	Tack Grade A Fabric	Tack Cork
30"w x 54"h x 19"d	\$655	\$720	\$775	\$775	\$620	\$680	\$740	\$740
36"w x 54"h x 19"d	\$690	\$760	\$820	\$820	\$640	\$705	\$760	\$760
42"w x 54"h x 19"d	\$715	\$790	\$850	\$850	\$655	\$720	\$780	\$780
30"w x 60"h x 19"d	\$665	\$730	\$790	\$790	\$655	\$720	\$775	\$775
36"w x 60"h x 19"d	\$695	\$770	\$820	\$820	\$655	\$730	\$790	\$790
42"w x 60"h x 19"d	\$735	\$810	\$890	\$890	\$690	\$760	\$825	\$825
30"w x 66"h x 19"d	\$690	\$760	\$820	\$820	\$695	\$770	\$820	\$820
36"w x 66"h x 19"d	\$715	\$790	\$850	\$850	\$705	\$780	\$835	\$835
42"w x 66"h x 19"d	\$755	\$830	\$890	\$890	\$965	\$1 060	\$1 120	\$1 120
60"w x 66" h x 19"d*	\$890	-	-	-	-	-	-	-

Custom sizes available - Select next larger size and add \$150 to list / item
 COM (customer's own material) Upcharge: \$150 List handling fee. Customer required to purchase fabric
 *Egan LiteProjection (VLF) - available with EVS on both sides.

Egan Lite Screen Door features a weighted trip-free base with exceptional stability and rotation through 360°. A 90° notch in the base provides compatibility with any wall or partition system. The no-lock front caster rolls smoothly and ensures door will fold back to permit free traffic flow.

Egan Lite Screen Doors can be specified with an EVS or Tackable infill per side. Pricing reflects costs for 1 side only. Choose an infill for each side and add the price together for the total cost. If the infill is the same for both sides, simply double the cost in the chart below.

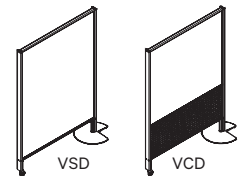

Table Shows Pricing Per Side of Board

Dimensions	SINGLE PANEL				SPLIT PANEL - TOP: EVS or TACK BOTTOM: PERFORATED PANEL			
	EVS	Tack Standard Fabric	Tack Grade A Fabric	Tack Cork	EVS	Tack Standard Fabric	Tack Grade A Fabric	Tack Cork
36"w x 54"h x 15"d	\$815	\$895	\$960	\$960	\$845	\$930	\$990	\$990
48"w x 54"h x 19"d	\$860	\$950	\$1 015	\$1 015	\$890	\$980	\$1 050	\$1 050
36"w x 60"h x 19"d	\$840	\$925	\$980	\$980	\$865	\$950	\$1 010	\$1 010
48"w x 60"h x 19"d	\$870	\$960	\$1 025	\$1 025	\$895	\$985	\$1 050	\$1 050

Custom sizes available - Select next larger size and add \$150 to list / item
 Lower Panel is perforated metal/ punched steel with 3/16" hole x 5/16" stagger
 Custom Fabric Upcharge: \$150 List handling fee. Customer required to purchase fabric - COM (customer's own material).

1. PRODUCT CODE

Code	Description
VLF	Egan Lite Caster Base
VLG	Egan Lite Glide Base
VSD	Egan Lite Screen Door
VCD	Egan Lite Screen Door - Split

2. SURFACE

Code	Description
E	EVS
F	Fabric
For a full list of Standard and Grade A fabric options, visit egan.com/fabrics-and-textiles/	

HOW TO ORDER

VSD 30 74 E F 463490-001 I

1. Product Code Width Height 2. Surface Side 1 Side 2 Maharam Fabric Pattern and Description EganINK File

A-Frame VersaMobile

A-Frame VersaMobiles offer two-sided high-performance EVS™ dry-erase surface. Specify any combination of EVS™ magnetic surface or Egan tackable fabric. A fixed track at the top of the A-Frame accommodates lightweight VersaBoards or EganSystem Track boards. Perfect for mobile presentations. Additional VersaBoards or 202 EganSystem Boards sold separately. Storage for up to five boards is available inside the spacious A-Frame shelf cavity. Ships with Clear Anodized (CA) aluminum finish.



A-Frame Mobiles can be specified with a different infill per side. Pricing reflects costs for 1 side only. Choose an infill for each side and add the price together for the total cost. If the infill is the same for both sides, simply double the cost in the chart below.

Table Shows Pricing Per Side of Board

Dimensions	Description	EVS/ per side	Tack Standard Fabric/ per side	Tack Grade A Fabric/ per side	Tack Cork/ per side
30"w x 74"h x 21"d	Stores up to five 26" x 36" VersaBoards, sold separately. EganSystem Boards are too large for this model.	\$1 170	\$1 290	\$1 350	\$1 350
36"w x 74"h x 21"d	Stores up to five 26" x 36" or 36" x 48" VersaBoards or up to five 36" x 48" 202 EganSystem markerboards, sold separately.	\$1 275	\$1 405	\$1 465	\$1 465
42"w x 74"h x 21"d	Stores up to five 26" x 36" or 36" x 48" VersaBoards or up to five 36" x 48" 202 EganSystem markerboards, sold separately.	\$1 375	\$1 520	\$1 575	\$1 575
48"w x 74"h x 21"d	Stores up to five 26" x 36" or 36" x 48" VersaBoards or up to five 36" x 48" 202 EganSystem markerboards, sold separately.	\$1 480	\$1 630	\$1 690	\$1 690

COM (customer's own material) Upcharge: \$150 List handling fee. Customer required to purchase fabric

1. PRODUCT CODE

Code	Description
KEA	A-Frame Mobile

2. SURFACE

Code	Description
E	EVS
F	Fabric
For a full list of Standard and Grade A fabric options, visit egan.com/fabrics-and-textiles/	

EGANINK

Specify EganINK on EVS for a minimum upcharge of \$200 or \$25/ sqft

HOW TO ORDER

KEA 30 74 E F 463490-001 I

1. Product Code Width Height 2. Surface Side 1 Side 2 Maharam Fabric Pattern and Description EganINK File

WHAT'S IN THE BOX

Two (2) assorted color Dry-Erase Markers
One (1) EganCloth

Egan TableScreens

■ Architrave

Architrave products are defined by their sturdy, wood oak Boxcore 1 1/8" (29mm) frame. Features of the Architrave family consist of thin bezel edge of 1/4" (6mm), a robust construction with a clean external appearance and no extraneous materials. Specify your Architrave TableScreen from a range of infill options, such as EVS, GlassWrite, Tackable fabric.

■ Boxcore 29

The rectilinear minimalist design of the Boxcore 29 presentation board is available as a versatile, demountable office enhancement in the form of the Boxcore 29 TableScreen™. Available in a range of infill options, such as EVS, GlassWrite and Tackable fabrics. Specify EganINK on any material to enhance productivity and design.

■ Dimension

The design principles of the Dimension family extend into the Dimension TableScreen, with its crisp, clean lines that promote a minimalist esthetic and create consistency and uniformity when specified with the Dimension line of Marker and Tackboards.

■ GlassWrite

The GlassWrite TableScreen is an elegant, framless 1/2" (13mm) thick singular piece of glass with polished and chamfered edges. Available in Frosted or Clear glass with the option to illuminate the GlassWrite panel with a LED light embedded into the base.

■ V-Series

Formerly M-Series, the V-Series TableScreen is part of the V-Series design family which has a sturdy aluminum frame and a range of infill options, such as: EVS, Frosted Glass, Cork and Tackable Fabric. The V-Series TableScreen also has a unique mount (as shown on page 53), making it extremely easy to install.

■ Fabric

Create functional privacy without compromising design elements in open concept environments. Available with 5 Standard Fabric patterns with a wide selection of colorways for each pattern or upgrade to Grade A Maharam fabrics. COM available contact Egan Rep or Egan Customer Service for details.

Egan TableScreens™ Mount Options

Surface Mount, Joiner Clamp, Cross Clamp and Edge Clamp are available on all Egan TableScreens™. Mount options shown below apply to Dimension, GlassWrite™, Architrave and Boxcore™ models. Dimension TableScreen shown below.

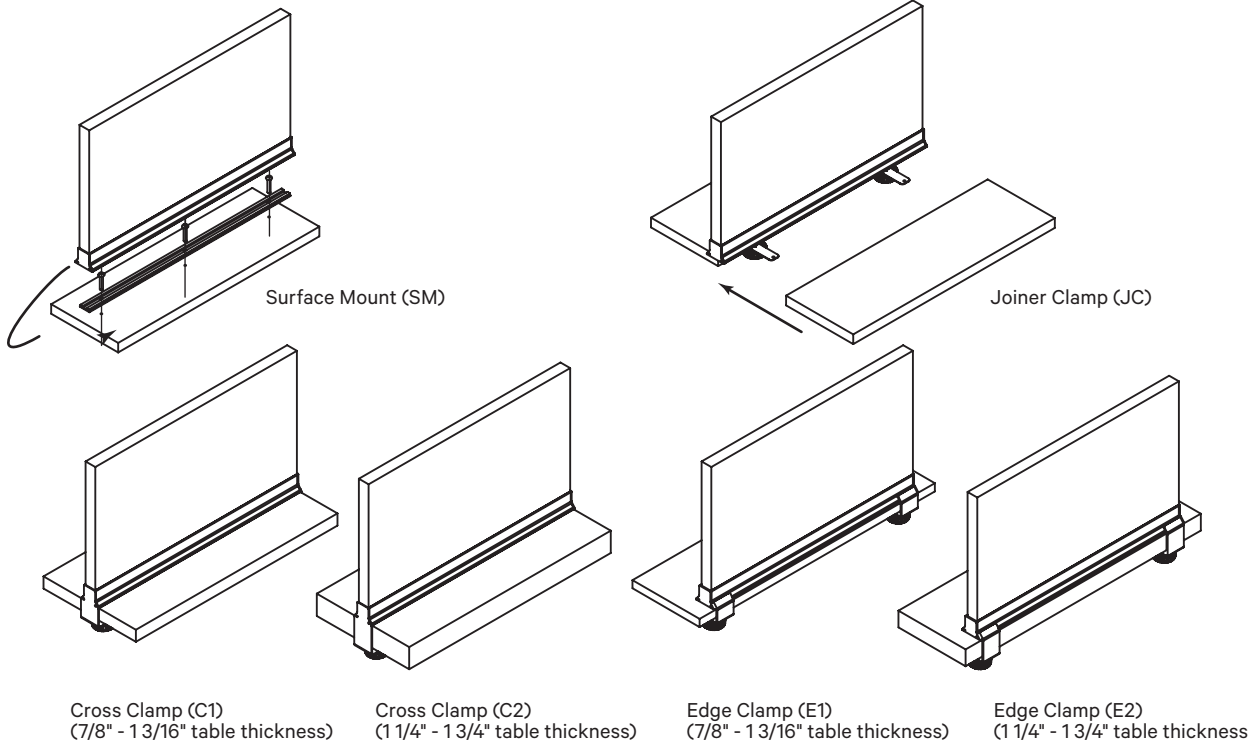

Surface Mount, Joiner Clamp, Cross Clamp and Edge Clamp are available on all Egan TableScreens™. Mount options shown below apply to V-Series TableScreens.

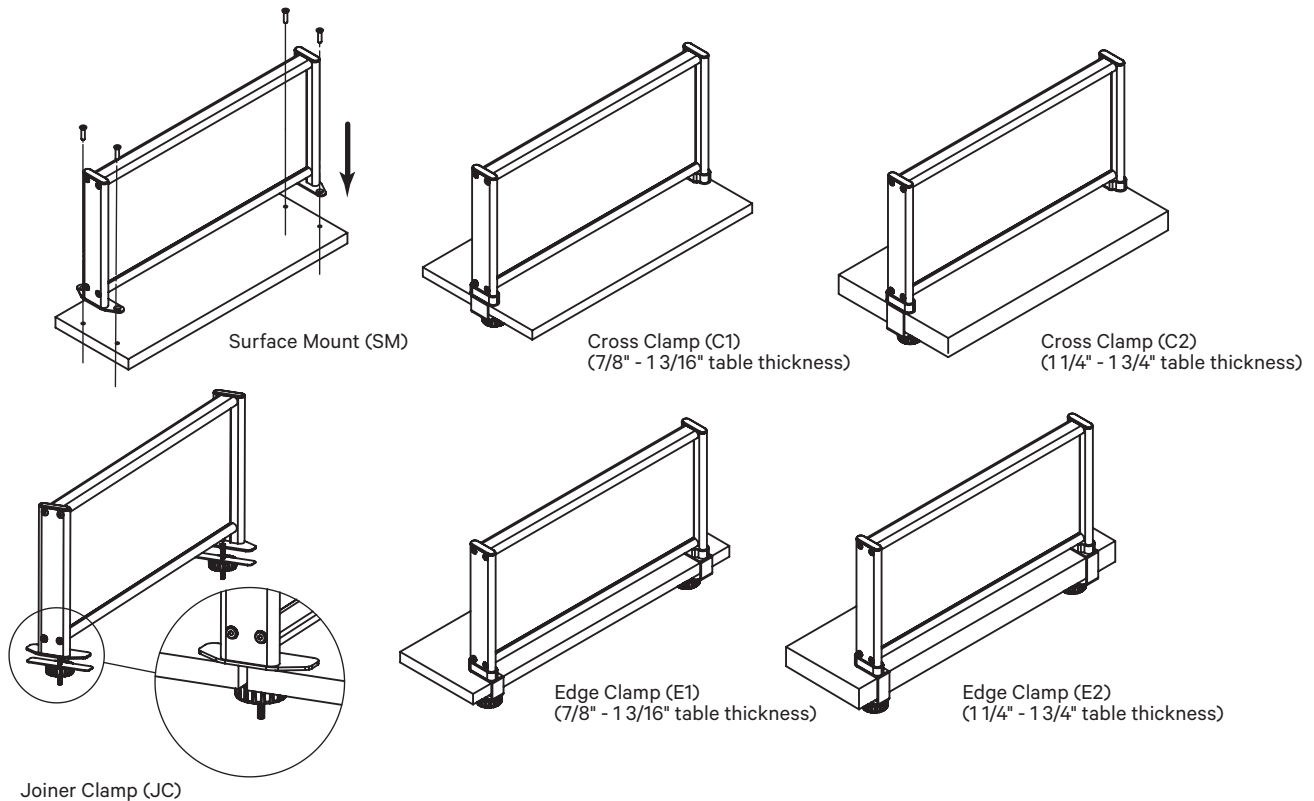

Parcel Service items (📦) ship 'Freight Included'.
Instant Ship products are identified by combining codes indicated in **RED**.

Architrave TableScreen

TableScreens can be specified with a different infill per side. Pricing reflects costs for 1 side only. Choose an infill for each side and add the price together for the total cost. If the infill is the same for both sides, simply double the cost in the chart below.

Table Shows Pricing Per Side of Board

Dimension	EVS/per side	Tack EcoTack/ per side	Tack Standard Fabric/ per side	Tack Grade A Fabric / per side
24"w x 12"h	\$335	\$335	\$370	\$450
24"w x 14"h	\$340	\$340	\$475	\$465
24"w x 18"h	\$345	\$345	\$380	\$470
24"w x 24"h	\$360	\$360	\$400	\$490
30"w x 12"h	\$355	\$355	\$390	\$495
30"w x 14"h	\$360	\$360	\$395	\$505
30"w x 18"h	\$375	\$375	\$415	\$530
30"w x 24"h	\$395	\$395	\$440	\$550
36"w x 12"h	\$365	\$365	\$400	\$505
36"w x 14"h	\$385	\$385	\$425	\$535
36"w x 18"h	\$405	\$405	\$445	\$570
36"w x 24"h	\$445	\$445	\$490	\$590
48"w x 12"h	\$380	\$380	\$420	\$525
48"w x 14"h	\$410	\$410	\$450	\$565
48"w x 18"h	\$445	\$445	\$490	\$615
48"w x 24"h	\$485	\$485	\$535	\$635
60"w x 12"h	\$410	\$410	\$450	\$584
60"w x 14"h	\$445	\$445	\$490	\$625
60"w x 18"h	\$480	\$480	\$530	\$670
60"w x 24"h	\$540	\$540	\$590	\$690
72"w x 12"h	\$435	\$435	\$480	\$630
72"w x 14"h	\$475	\$475	\$525	\$680
72"w x 18"h	\$510	\$510	\$560	\$720
72"w x 24"h	\$575	\$575	\$635	\$750

Custom sizes available - Use price from the next larger size. For example, 20"w x 12"h use pricing from the next larger size (24"w x 12"h)
COM (customer's own material) Upcharge: \$150 List handling fee. Customer required to purchase fabric

TableScreens

1. PRODUCT CODE

Code	Description
TSA	EVS Framed

3. SURFACE

Code	Description
E	EVS
T	EcoTack/PET
F	Fabric
For a full list of Standard and Grade A fabric options, visit egan.com/fabrics-and-textiles/	

4. FRAME STAINS

Code	Description
LO	Light Oak
MO	Medium Oak
DO	Dark Oak
BO	Black Oak
CS	Custom Stain - \$ 250

EGANINK

Specify EganINK on EVS or Glass for a minimum upcharge of \$200 or \$25/ sqft

2. MOUNT

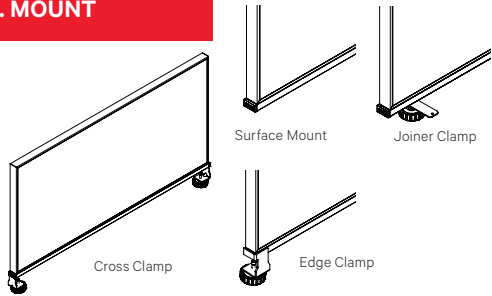

Code	Description
E1	Install TableScreen along the edge of a 7/8" to 1 3/16" thick table using an Edge Clamp.
E2	Install TableScreen along the edge of a 1 1/4" to 1 3/4" thick table using an Edge Clamp.
C1	Install TableScreen across a surface of a 7/8" to 1 3/16" thick table using a Cross Clamp.
C2	Install TableScreen across a surface of a 1 1/4" to 1 3/4" thick table using a Cross Clamp.
SM	Install TableScreen across a surface or along the edge of a table using a Surface Mount.
JC	Install TableScreen along the seams of two adjacent tables using a Joiner Clamp.

HOW TO ORDER



WHAT'S IN THE BOX

Two (2) assorted color Dry-Erase Markers
One (1) EganCloth

Architrave TableScreen GlassWrite

Distinguished by a sturdy 1 1/8" wood oak frame, Architrave TableScreen is available in four distinct stains and comes with various infill options. GlassWrite is built from a guaranteed-to-clean, crystal clear, low iron tempered safety glass for high clarity of surface. GlassWrite is neo-magent compatible and is available with Egan Infinite Palette - choose from 1,050 standard glass colors.

Dimension	GlassWrite MAG
24"w x 12"h	\$1 010
24"w x 14"h	\$1 120
24"w x 18"h	\$1 330
24"w x 24"h	\$1 720
30"w x 12"h	\$1 180
30"w x 14"h	\$1 350
30"w x 18"h	\$1 610
30"w x 24"h	\$2 040
36"w x 12"h	\$1 350
36"w x 14"h	\$1 560
36"w x 18"h	\$1 890
36"w x 24"h	\$2 380
48"w x 12"h	\$1 740
48"w x 14"h	\$1 970
48"w x 18"h	\$2 396
48"w x 24"h	\$3 210
60"w x 12"h	\$2 130
60"w x 14"h	\$2 450
60"w x 18"h	\$2 990
60"w x 24"h	\$3 580
72"w x 12"h	\$2 480
72"w x 14"h	\$2 940
72"w x 18"h	\$3 570
72"w x 24"h	\$4 220

GlassWrite MAG cannot be specified with other infills.

Custom sizes available - Use price from the next larger size. For example, 20"w x 12"h use pricing from the next larger size (24"w x 12"h)

1. PRODUCT CODE

Code	Description
TSA	GlassWrite

3. SURFACE

Code	Description
GG	GlassWriteMAG

4. GLASS COLOR

Code	Description	Price
WH	White	\$ 0
IP	Infinite Color Program	\$ 0
CC	Custom Color	\$ 150

Visit egan.com or pantone.com for colors.

5. FRAME STAINS

Code	Description
LO	Light Oak
MO	Medium Oak
DO	Dark Oak
BO	Black Oak
CS	Custom Stain - \$ 250

EGANINK Specify EganINK on EVS or Glass for a minimum upcharge of \$200 or \$25/ sqft

2. MOUNT

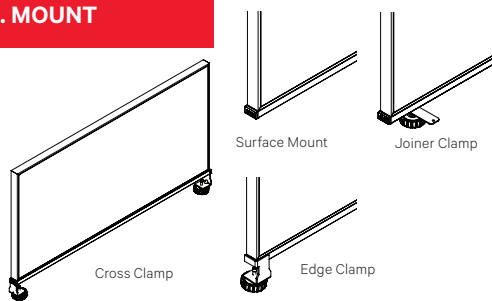

Code	Description
E1	Install TableScreen along the edge of a 7/8" to 1 3/16" thick table using an Edge Clamp.
E2	Install TableScreen along the edge of a 1 1/4" to 1 3/4" thick table using an Edge Clamp.
C1	Install TableScreen across a surface of a 7/8" to 1 3/16" thick table using a Cross Clamp.
C2	Install TableScreen across a surface of a 1 1/4" to 1 3/4" thick table using a Cross Clamp.
SM	Install TableScreen across a surface or along the edge of a table using a Surface Mount.
JC	Install TableScreen along the seams of two adjacent tables using a Joiner Clamp.

HOW TO ORDER

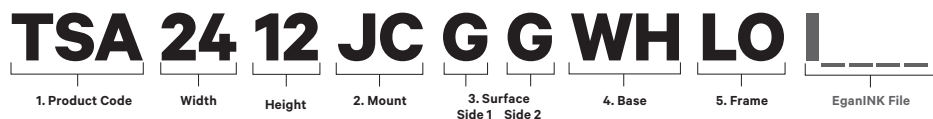

WHAT'S IN THE BOX

Two (2) assorted color Dry-Erase Markers
One (1) EganCloth

Boxcore™ 29 TableScreens™

TableScreens can be specified with a different infill per side. Pricing reflects costs for 1 side only. Choose an infill for each side and add the price together for the total cost. If the infill is the same for both sides, simply double the cost in the chart below.

Table Shows Pricing Per Side of Board

Dimension	EVS /per side	Tack EcoTack / per side	Tack Standard Fabric/ per side	Tack Grade A Fabric / per side
24"w x 12"h	\$335	\$335	\$370	\$450
24"w x 14"h	\$340	\$340	\$475	\$465
24"w x 18"h	\$345	\$345	\$380	\$470
24"w x 24"h	\$360	\$360	\$400	\$490
30"w x 12"h	\$355	\$355	\$390	\$495
30"w x 14"h	\$360	\$360	\$395	\$505
30"w x 18"h	\$375	\$375	\$415	\$530
30"w x 24"h	\$395	\$395	\$440	\$550
36"w x 12"h	\$365	\$365	\$400	\$505
36"w x 14"h	\$385	\$385	\$425	\$535
36"w x 18"h	\$405	\$405	\$445	\$570
36"w x 24"h	\$445	\$445	\$490	\$590
48"w x 12"h	\$380	\$380	\$420	\$525
48"w x 14"h	\$410	\$410	\$450	\$565
48"w x 18"h	\$445	\$445	\$490	\$615
48"w x 24"h	\$485	\$485	\$535	\$635
60"w x 12"h	\$410	\$410	\$450	\$584
60"w x 14"h	\$445	\$445	\$490	\$625
60"w x 18"h	\$480	\$480	\$530	\$670
60"w x 24"h	\$540	\$540	\$590	\$690
72"w x 12"h	\$435	\$435	\$480	\$630
72"w x 14"h	\$475	\$475	\$525	\$680
72"w x 18"h	\$510	\$510	\$560	\$720
72"w x 24"h	\$575	\$575	\$635	\$750

Custom sizes available - Use price from the next larger size. For example, 20"w x 12"h use pricing from the next larger size (24"w x 12"h)
 Custom Fabric Upcharge: \$150 List handling fee. Customer required to purchase fabric COM (customer's own material).

1. PRODUCT CODE

Code	Description
TSB	EVS Framed

3. SURFACE

Code	Description
E	EVS
T	EcoTack/PET
F	Fabric

For a full list of Standard and Grade A fabric options, visit egan.com/fabrics-and-textiles/

4. FRAME & BASE

Code	Description
CA	Clear Anodized
WH	White
BL	Black
CC	Custom Color - \$ 150

EGANINK

Specify EganINK on EVS or Glass for a minimum upcharge of \$200 or \$25/ sqft

2.MOUNT

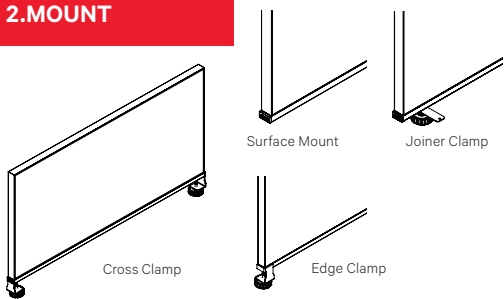

Code	Description
E1	Install TableScreen along the edge of a 7/8" to 1 3/16" thick table using an Edge Clamp.
E2	Install TableScreen along the edge of a 1 1/4" to 1 3/4" thick table using an Edge Clamp.
C1	Install TableScreen across a surface of a 7/8" to 1 3/16" thick table using a Cross Clamp.
C2	Install TableScreen across a surface of a 1 1/4" to 1 3/4" thick table using a Cross Clamp.
SM	Install TableScreen across a surface or along the edge of a table using a Surface Mount.
JC	Install TableScreen along the seams of two adjacent tables using a Joiner Clamp.

HOW TO ORDER

TSB 24 12 JC E E WH CA I

1. Product Code Width Height 2. Mount 2. Surface Side 1 Side 2 4. Frame 4. Base EganINK File

WHAT'S IN THE BOX

Two (2) assorted color Dry-Erase Markers
 One (1) EganCloth

Boxcore™ 29 TableScreens™ GlassWrite

Distinguished by an ultra-thin bezel, and a clear anodized aluminum frame in 1 1/8" (29mm) depth. The Boxcore TableScreen GlassWrite is built from a guaranteed-to-clean, crystal clear, low iron tempered safety glass for high clarity of surface. GlassWrite is neo-magent compatible and is available with Egan Infinite Palette - choose from 1,050 standard glass colors.

Dimension	GlassWrite MAG
24"w x 12"h	\$1 010
24"w x 14"h	\$1 120
24"w x 18"h	\$1 330
24"w x 24"h	\$1 720
30"w x 12"h	\$1 180
30"w x 14"h	\$1 350
30"w x 18"h	\$1 610
30"w x 24"h	\$2 040
36"w x 12"h	\$1 350
36"w x 14"h	\$1 560
36"w x 18"h	\$1 890
36"w x 24"h	\$2 040
48"w x 12"h	\$1 740
48"w x 14"h	\$1 970
48"w x 18"h	\$2 396
48"w x 24"h	\$3 210
60"w x 12"h	\$2 130
60"w x 14"h	\$2 450
60"w x 18"h	\$2 990
60"w x 24"h	\$3 580
72"w x 12"h	\$2 480
72"w x 14"h	\$2 940
72"w x 18"h	\$3 496
72"w x 24"h	\$4 220

Custom sizes available - Use price from the next larger size. For example, 20"w x 12"h use pricing from the next larger size (24"w x 12"h)

1. PRODUCT CODE

Code	Description
TSGB	GlassWriteMAG

3. GLASS COLOR

Code	Description
WH	White
CC	Infinite Color Program
Visit egan.com or pantone.com for colors.	

4. FRAME & BASE

Code	Description
CA	Clear Anodized
WH	White
BL	Black
CC	Custom Color - \$ 150

EGANINK

Specify EganINK on EVS or Glass for a minimum upcharge of \$200 or \$25/ sqft

2.MOUNT

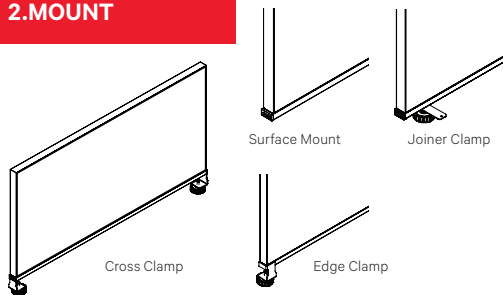

Code	Description
E1	Install TableScreen along the edge of a 7/8" to 1 3/16" thick table using an Edge Clamp.
E2	Install TableScreen along the edge of a 1 1/4" to 1 3/4" thick table using an Edge Clamp.
C1	Install TableScreen across a surface of a 7/8" to 1 3/16" thick table using a Cross Clamp.
C2	Install TableScreen across a surface of a 1 1/4" to 1 3/4" thick table using a Cross Clamp.
SM	Install TableScreen across a surface or along the edge of a table using a Surface Mount.
JC	Install TableScreen along the seams of two adjacent tables using a Joiner Clamp.

HOW TO ORDER

TSGB 24 12 JC WH WH CA I

1. Product Code Width Height 2. Mount 3. Glass Color Side 1 Side 2 4. Frame & Base EganINK File

WHAT'S IN THE BOX

Two (2) assorted color Dry-Erase Markers
One (1) EganCloth

GlassWrite TableScreens™

TableScreens can be specified with a one infill/ material only. Pricing reflects costs for both sides.

Dimension	GlassWrite Clear	GlassWrite Frosted	GlassWrite Lumens
24"w x 12"h	\$640	\$640	\$880
24"w x 14"h	\$680	\$680	\$910
30"w x 12"h	\$730	\$730	\$980
30"w x 14"h	\$780	\$780	\$1 040
36"w x 12"h	\$1 010	\$1 010	\$1 290
36"w x 14"h	\$1 070	\$1 070	\$1 350
48"w x 12"h	\$1 295	\$1 295	\$1 630
48"w x 14"h	\$1 370	\$1 370	\$1 695
60"w x 12"h	\$1 460	\$1 460	\$1 840
60"w x 14"h	\$1 550	\$1 550	\$1 930
72"w x 12"h	\$1 595	\$1 595	\$2 030
72"w x 14"h	\$1 690	\$1 690	\$2 130

Custom sizes available - Use price from the next larger size. For example, 20"w x 12"h use pricing from the next larger size (24"w x 12"h)
 Custom Fabric Upcharge: \$150 List handling fee. Customer required to purchase fabric COM (customer's own material).

1. PRODUCT CODE

Code	Description
TSG	GlassWrite Frameless

3. SURFACE

Code	Description
GC	Clear
GF	Frosted

4. OPTION

Code	Description
L	Lumens

2. MOUNT

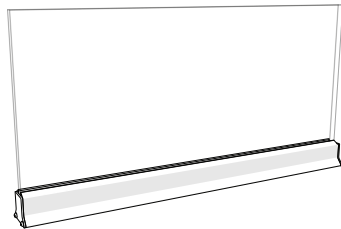

Code	Description
E1	Install TableScreen along the edge of a 7/8" to 1 3/16" thick table using an Edge Clamp.
E2	Install TableScreen along the edge of a 1 1/4" to 1 3/4" thick table using an Edge Clamp.
C1	Install TableScreen across a surface of a 7/8" to 1 3/16" thick table using a Cross Clamp.
C2	Install TableScreen across a surface of a 1 1/4" to 1 3/4" thick table using a Cross Clamp.
SM	Install TableScreen across a surface or along the edge of a table using a Surface Mount.
JC	Install TableScreen along the seams of two adjacent tables using a Joiner Clamp.

HOW TO ORDER

TSG 24 14 E1 GC L

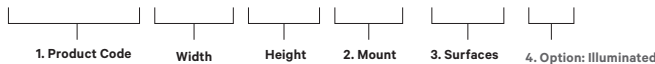

WHAT'S IN THE BOX

Two (2) assorted color Dry-Erase Markers
 One (1) EganCloth

Dimension Stele™ TableScreens™

TableScreens can be specified with a different infill per side. Pricing reflects costs for 1 side only. Choose an infill for each side and add the price together for the total cost. If the infill is the same for both sides, simply double the cost in the chart below.

Table Shows Pricing Per Side of Board

Dimension	EVS/per side	Tack EcoTack/per side	Tack Standard Fabric/per side	Tack Grade A Fabric/per side
24"w x 12"h	\$230	\$230	\$270	\$295
24"w x 14"h	\$235	\$235	\$280	\$305
24"w x 18"h	\$240	\$240	\$185	\$310
30"w x 12"h	\$245	\$245	\$300	\$330
30"w x 14"h	\$255	\$255	\$310	\$345
30"w x 18"h	\$270	\$270	\$320	\$360
36"w x 12"h	\$265	\$265	\$315	\$345
36"w x 14"h	\$280	\$280	\$380	\$360
36"w x 18"h	\$295	\$295	\$350	\$424
48"w x 12"h	\$280	\$280	\$335	\$370
48"w x 14"h	\$300	\$300	\$365	\$400
48"w x 18"h	\$335	\$335	\$390	\$430
60"w x 12"h	\$300	\$300	\$365	\$410
60"w x 14"h	\$330	\$330	\$295	\$440
60"w x 18"h	\$360	\$360	\$125	\$470
72"w x 12"h	\$325	\$325	\$180	\$435
72"w x 14"h	\$360	\$360	\$425	\$475
72"w x 18"h	\$390	\$390	\$460	\$515

1. PRODUCT CODE

Code	Description
TSDM	Dimension Frameless

3. SURFACE

Code	Description
E	EVS
T	EcoTack/PET
F	Fabric
For a full list of Standard and Grade A fabric options, visit egan.com/fabrics-and-textiles/	

EGANINK

Specify EganINK on EVS for a minimum upcharge of \$200 or \$25/ sqft

Custom sizes available - Use price from the next larger size. For example, 20"w x 12"h use pricing from the next larger size (24"w x 12"h)
 Custom Fabric Upcharge: \$150 List handling fee. Customer required to purchase fabric COM (customer's own material).

2. MOUNT

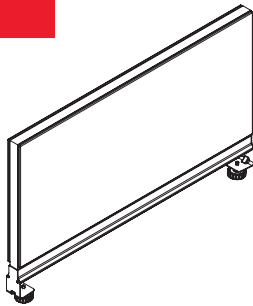

Code	Description
E1	Install TableScreen along the edge of a 7/8" to 1 3/16" thick table using an Edge Clamp.
E2	Install TableScreen along the edge of a 1 1/4" to 1 3/4" thick table using an Edge Clamp.
C1	Install TableScreen across a surface of a 7/8" to 1 3/16" thick table using a Cross Clamp.
C2	Install TableScreen across a surface of a 1 1/4" to 1 3/4" thick table using a Cross Clamp.
SM	Install TableScreen across a surface or along the edge of a table using a Surface Mount.
JC	Install TableScreen along the seams of two adjacent tables using a Joiner Clamp.

HOW TO ORDER



WHAT'S IN THE BOX

Two (2) assorted color Dry-Erase Markers
 One (1) EganCloth

V-Series TableScreens™

TableScreens can be specified with a different infill per side. Pricing reflects costs for 1 side only. Choose an infill for each side and add the price together for the total cost. If the infill is the same for both sides, simply double the cost in the chart below.

Table Shows Pricing Per Side of Board

Dimension	EVS/ per side	GlassWrite Frosted/ per side	Tack EcoTack/ per side	Tack Standard Fabric /per side	Tack Grade A Fabric/ per side	Tack Cork/ per side
24"w x 12"h	\$330	\$365	\$330	\$360	\$410	\$410
24"w x 14"h	\$335	\$370	\$335	\$370	\$420	\$420
24"w x 18"h	\$340	\$375	\$340	\$375	\$425	\$425
30"w x 12"h	\$340	\$375	\$340	\$375	\$435	\$435
30"w x 14"h	\$355	\$390	\$355	\$390	\$460	\$460
30"w x 18"h	\$365	\$400	\$365	\$400	\$475	\$475
36"w x 12"h	\$355	\$390	\$355	\$390	\$450	\$450
36"w x 14"h	\$370	\$405	\$370	\$410	\$475	\$475
36"w x 18"h	\$385	\$420	\$385	\$425	\$500	\$500
48"w x 12"h	\$370	\$405	\$370	\$410	\$470	\$470
48"w x 14"h	\$390	\$425	\$390	\$430	\$500	\$500
48"w x 18"h	\$415	\$450	\$415	\$455	\$530	\$530
60"w x 12"h	\$335	\$370	\$335	\$370	\$455	\$455
60"w x 14"h	\$415	\$450	\$415	\$455	\$540	\$540
60"w x 18"h	\$445	\$480	\$445	\$490	\$575	\$575
72"w x 12"h	\$405	\$440	\$405	\$445	\$545	\$545
72"w x 14"h	\$435	\$470	\$435	\$480	\$580	\$580
72"w x 18"h	\$470	\$505	\$470	\$520	\$615	\$615

1. PRODUCT CODE

Code	Description
TSM	V-Series Framed

3. SURFACE

Code	Description
E	EVS
G	Frosted Glass
K	Natural Cork
T	EcoTack/PET
F	Fabric

For a full list of Standard and Grade A fabric options, visit egan.com/fabrics-and-textiles/

EGANINK

Specify EganINK on EVS or Glass for a minimum upcharge of \$200 or \$25/ sqft

Custom sizes available - Use price from the next larger size. For example, 20"w x 12"h use pricing from the next larger size (24"w x 12"h)

Custom Fabric Upcharge: \$150 List handling fee. Customer required to purchase fabric

COM (customer's own material).

Custom Color Frame upcharge: \$150/ product

2. MOUNT

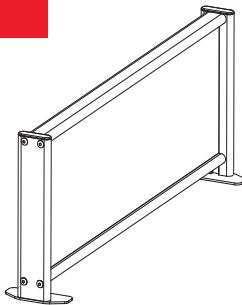

Code	Description
E1	Install TableScreen along the edge of a 7/8" to 1 3/16" thick table using an Edge Clamp.
E2	Install TableScreen along the edge of a 1 1/4" to 1 3/4" thick table using an Edge Clamp.
C1	Install TableScreen across a surface of a 7/8" to 1 3/16" thick table using a Cross Clamp.
C2	Install TableScreen across a surface of a 1 1/4" to 1 3/4" thick table using a Cross Clamp.
SM	Install TableScreen across a surface or along the edge of a table using a Surface Mount.
JC	Install TableScreen along the seams of two adjacent tables using a Joiner Clamp.

HOW TO ORDER



WHAT'S IN THE BOX

Two (2) assorted color Dry-Erase Markers
One (1) EganCloth

FabricTableScreens™

TableScreens can be specified with a one infill/ material only. Pricing reflects costs for both sides.

Dimension	Tack Standard Fabric	Tack Grade A Fabric
24"w x 12"h	\$760	\$830
24"w x 14"h	\$800	\$870
24"w x 18"h	\$825	\$900
30"w x 12"h	\$800	\$900
30"w x 14"h	\$825	\$925
30"w x 18"h	\$860	\$980
36"w x 12"h	\$825	\$920
36"w x 14"h	\$860	\$960
36"w x 18"h	\$915	\$1 035
48"w x 12"h	\$960	\$1 055
48"w x 14"h	\$980	\$1 080
48"w x 18"h	\$1 045	\$1 170
60"w x 12"h	\$1 000	\$1 155
60"w x 14"h	\$1 035	\$1 190
60"w x 18"h	\$1 110	\$1 265
72"w x 12"h	\$1 065	\$1 240
72"w x 14"h	\$1 190	\$1 360
72"w x 18"h	\$1 255	\$1 425

1. PRODUCT CODE

Code	Description
TSF	Fabric Frameless

3. SURFACE

Code	Description
F	Fabric
For a full list of Standard and Grade A fabric options, visit egan.com/fabrics-and-textiles/	

Custom sizes available - Use price from the next larger size. For example, 20"w x 12"h use pricing from the next larger size (24"w x 12"h)
 Custom Fabric Upcharge: \$150 List handling fee. Customer required to purchase fabric COM (customer's own material).

2. MOUNT

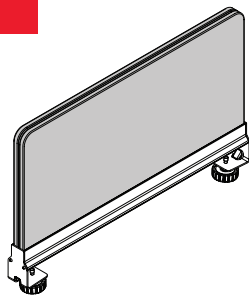

Code	Description
E1	Install TableScreen along the edge of a 7/8" to 1 3/16" thick table using an Edge Clamp.
E2	Install TableScreen along the edge of a 1 1/4" to 1 3/4" thick table using an Edge Clamp.
C1	Install TableScreen across a surface of a 7/8" to 1 3/16" thick table using a Cross Clamp.
C2	Install TableScreen across a surface of a 1 1/4" to 1 3/4" thick table using a Cross Clamp.
SM	Install TableScreen across a surface or along the edge of a table using a Surface Mount.
JC	Install TableScreen along the seams of two adjacent tables using a Joiner Clamp.

HOW TO ORDER

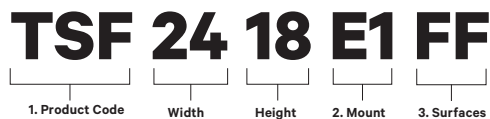

Sound Ideas

Egan can provide a tailored sound analysis on how to reduce reverberation and decibels in your environment. Contact Egan or your local Rep for more details: www.egan.com/rep-locator/

■ Egan Disperse™

The all-new Egan Disperse™ Acoustical Panels gives you new ways to influence your space and enhance people's experience within it. Thanks to its sound-damping core (PET with an NRC rating of 0.75) and surface design, you have enhanced ability to influence sounds, particularly in open spaces. For a unique and highly customizable visual design element turn to Egan Disperse Acoustical Panels. Egan Disperse mobiles can help with sound mitigation in many environments. Front-facing apertures in the surface available in Egan's wood veneer for the infills, or specify Etex in a number of colors. Also available in wall mounted panels.

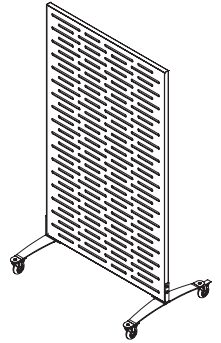

■ Acoustical Wall Panels

Form and function work together to provide visually interesting installations while reducing ambient noise and increasing workplace productivity. Egan acoustic panels are designed to help control echo and sound bounce within a room, and to stop sound from escaping or entering a room.

Series 3 panels are an ideal solution to effectively reducing dB levels in a room. These panels have an NRC rating of .85 (1") and 1.05 (2"). Specify your choice of acoustic fabric from Guilford of Maine, select Maharam, and COM fabrics.

■ Decorative Tack

Decorative Tack is designed for use on walls where a long lasting tackable surface is needed. While dampening noise, Decorative Tack can also be used as attractive, visual installations that add color and texture to a room. Available in 1/2" thickness with an NRC rating of .35 and STC rating of 25

Egan Disperse™

Egan Disperse mobiles help with sound mitigation in open spaces. Thanks to its sound-damping core and surface design, you have enhanced ability to influence sounds. Front-facing apertures in the surface are available in Egan's wood or Etex in a number of colors.

DISPERSE MOBILE		
	Etex	Veneer
36"w x 54"h	\$3 140	\$3 370
48"w x 54"h	\$3 230	\$3 390
36"w x 60"h	\$3 290	\$3 560
48"w x 60"h	\$3 680	\$3 940
36"w x 72"h	\$3 340	\$3 680
48"w x 72"h	\$3 620	\$3 970

DISPERSE WALL MOUNT		
	Etex	Veneer
24"w x 36"h	\$920	\$995
48"w x 36"h	\$1 380	\$1 570
48"w x 48"h	\$1 630	\$1 780
60"w x 48"h	\$1 940	\$2 120
72"w x 48"h	\$2 220	\$2 550
96"w x 48"h	\$2 840	\$2 970

1. PRODUCT CODE

Code	Description
SIM	Disperse Mobile
SIW	Disperse Wall Mount

2. CORE FINISH

Code	Description
T	EcoTack EganMetallic

3. SURFACE FINISH

Wood Veneer Stains	
Code	Description
LO	Light Oak
MO	Medium Oak
DO	Dark Oak
BO	Black Oak
MA	Mahogany
CH	Cherry
MP	Natural Maple
WA	Walnut
Custom Stain available Add \$250 to list, per item	

Etex Color Options	
Code	Description
EM	EganMetallic
BL	Black
CL	Charcoal
GR	Gray
PT	Platinum
PY	Putty
SN	Sand
SL	Slate
TA	Taupe
Custom Color available Add \$150 to list, per item	

4. FRAME COLOR

Code	Description	Price
WH	White	\$ 0
BL	Black	\$ 0
CA	Clear Anodized	\$ 0
CC	Custom Color	\$ 150

5. BASE COLOR

Code	Description	Price
WH	White	\$ 0
BL	Black	\$ 0
CA	Clear Anodized	\$ 0
CC	Custom Color	\$ 150

HOW TO ORDER

SIM EB 36 72 WA WA CA EM

1. Product Code 2. Core Finish Width Height 3. Surface Finish Side 1 Side 2 4. Frame Color 5. Base Color (Mobile only)

Acoustical Panel System - Series 3

Series 3 panels are used extensively in auditoriums, conference rooms, offices, open plan areas, classrooms, and many other areas where the sound levels need adjusting. Designed to reduce dB levels, these acoustical panels have a NRC rating of .85 (1") and 1.05 (2").

1" Panel Thickness (Base list price Standard Fabric)

Inches	12"	18"	24"	30"	36"	42"	48"
12"	\$152	\$160	\$177	\$192	\$207	\$221	\$232
18"	\$160	\$181	\$200	\$221	\$244	\$265	\$282
24"	\$177	\$200	\$229	\$255	\$281	\$311	\$334
30"	\$192	\$221	\$255	\$287	\$318	\$352	\$381
36"	\$207	\$244	\$281	\$318	\$415	\$455	\$490
42"	\$221	\$265	\$311	\$352	\$455	\$552	\$592
48"	\$232	\$282	\$334	\$381	\$490	\$592	\$639
54"	\$247	\$303	\$357	\$455	\$544	\$636	\$690
60"	\$289	\$350	\$416	\$524	\$645	\$747	\$807
66"	\$332	\$394	\$468	\$594	\$723	\$850	\$915
72"	\$344	\$419	\$503	\$631	\$758	\$897	\$965
78"	\$358	\$439	\$529	\$665	\$807	\$936	\$1 010
84"	\$398	\$487	\$584	\$734	\$891	\$1 033	\$1 116
90"	\$444	\$534	\$634	\$799	\$965	\$1 129	\$1 218
96"	\$455	\$552	\$658	\$828	\$1 000	\$1 171	\$1 265
102"	\$526	\$634	\$791	\$902	\$1 074	\$1 220	\$1 321
108"	\$549	\$655	\$820	\$934	\$1 118	\$1 270	\$1 373
114"	\$561	\$671	\$844	\$970	\$1 154	\$1 310	\$1 421
120"	\$571	\$695	\$882	\$997	\$1 187	\$1 352	\$1 468

1" Panel Thickness (Base list price Grade A Fabric)

Inches	12"	18"	24"	30"	36"	42"	48"
12"	\$236	\$244	\$262	\$277	\$291	\$306	\$317
18"	\$244	\$265	\$285	\$306	\$328	\$349	\$367
24"	\$262	\$285	\$314	\$340	\$365	\$396	\$419
30"	\$277	\$306	\$340	\$372	\$403	\$436	\$465
36"	\$291	\$328	\$365	\$403	\$536	\$576	\$611
42"	\$306	\$349	\$396	\$436	\$576	\$673	\$713
48"	\$317	\$367	\$419	\$465	\$611	\$713	\$760
54"	\$381	\$438	\$491	\$589	\$678	\$770	\$825
60"	\$423	\$484	\$550	\$659	\$780	\$881	\$941
66"	\$467	\$528	\$602	\$728	\$857	\$984	\$1 049
72"	\$491	\$567	\$651	\$778	\$906	\$1 044	\$1 112
78"	\$506	\$586	\$677	\$812	\$954	\$1 083	\$1 157
84"	\$546	\$635	\$731	\$881	\$1 038	\$1 180	\$1 264
90"	\$605	\$696	\$796	\$960	\$1 126	\$1 291	\$1 380
96"	\$617	\$713	\$820	\$989	\$1 162	\$1 333	\$1 483
102"	\$688	\$796	\$952	\$1 064	\$1 236	\$1 381	\$1 483
108"	\$737	\$843	\$1 008	\$1 122	\$1 306	\$1 458	\$1 561
114"	\$750	\$859	\$1 032	\$1 158	\$1 342	\$1 498	\$1 609
120"	\$759	\$883	\$1 071	\$1 185	\$1 375	\$1 540	\$1 656

2" Panel Thickness (Base list price Standard Fabric)

Inches	12"	18"	24"	30"	36"	42"	48"
12"	\$155	\$165	\$182	\$197	\$215	\$231	\$242
18"	\$165	\$186	\$207	\$231	\$255	\$277	\$297
24"	\$182	\$207	\$239	\$266	\$295	\$328	\$353
30"	\$197	\$231	\$266	\$302	\$334	\$371	\$403
36"	\$215	\$255	\$295	\$334	\$436	\$479	\$518
42"	\$231	\$277	\$328	\$371	\$479	\$579	\$624
48"	\$242	\$297	\$353	\$403	\$518	\$624	\$676
54"	\$258	\$319	\$378	\$481	\$576	\$671	\$732
60"	\$300	\$366	\$439	\$552	\$678	\$786	\$850
66"	\$345	\$413	\$494	\$626	\$760	\$895	\$965
72"	\$358	\$440	\$531	\$665	\$799	\$945	\$1 020
78"	\$374	\$461	\$560	\$702	\$850	\$987	\$1 070
84"	\$415	\$511	\$615	\$773	\$939	\$1 087	\$1 179
90"	\$461	\$560	\$666	\$841	\$1 016	\$1 187	\$1 284
96"	\$474	\$579	\$695	\$873	\$1 055	\$1 341	\$1455
102"	\$547	\$663	\$831	\$950	\$1 133	\$1 286	\$1 397
108"	\$568	\$687	\$860	\$984	\$1 179	\$1 341	\$1 455
114"	\$584	\$703	\$886	\$1 023	\$1 218	\$1 384	\$1507
120"	\$592	\$728	\$926	\$1 053	\$1 255	\$1 429	\$1 557

2" Panel Thickness (Base list price Grade A Fabric)

Inches	12"	18"	24"	30"	36"	42"	48"
12"	\$240	\$249	\$267	\$282	\$299	\$315	\$327
18"	\$249	\$270	\$291	\$315	\$340	\$362	\$382
24"	\$267	\$291	\$323	\$351	\$380	\$412	\$438
30"	\$282	\$315	\$351	\$386	\$419	\$456	\$488
36"	\$299	\$340	\$380	\$455	\$557	\$600	\$639
42"	\$315	\$362	\$412	\$492	\$600	\$700	\$745
48"	\$327	\$382	\$438	\$524	\$639	\$745	\$797
54"	\$379	\$440	\$499	\$602	\$697	\$792	\$853
60"	\$434	\$500	\$573	\$686	\$812	\$920	\$984
66"	\$493	\$560	\$641	\$773	\$907	\$1043	\$1112
72"	\$506	\$588	\$678	\$812	\$946	\$1093	\$1167
78"	\$522	\$609	\$707	\$849	\$998	\$1135	\$1217
84"	\$576	\$673	\$776	\$934	\$1101	\$1249	\$1341
90"	\$623	\$722	\$828	\$1002	\$1178	\$1349	\$1446
96"	\$636	\$741	\$857	\$1034	\$1217	\$1396	\$1498
102"	\$735	\$851	\$1019	\$1138	\$1321	\$1474	\$1585
108"	\$756	\$875	\$1048	\$1172	\$1367	\$1529	\$1643
114"	\$772	\$892	\$1074	\$1211	\$1406	\$1572	\$1695
120"	\$793	\$929	\$1127	\$1255	\$1456	\$1631	\$1758

Custom sizes available - Select next larger size and add \$150 to list / item

Custom Fabric Upcharge: \$150 List handling fee. Customer required to purchase fabric COM (customer's own material).

Acoustical Panel System - Series 3

1. PRODUCT CODE

Code	Description
SIAPS31	Acoustical Panel System - 3 1"
SIAPS32	Acoustical Panel System - 3 2"

3. EDGE DETAIL

Code	Description
S	Square

2. MOUNTS

Mount Option	Price	Code
Z-Clip	Add 5% - \$55 min	Z
Impaling Clip	Spot Quote - Call CS	I
Velcro	Spot Quote - Call CS	V

4. CORNER DETAIL

Code	Description
S	Square

RATINGS

Noise Reduction Coefficient - NRC
1" .85
2" 1.05

5. FABRIC

Acoustic Fabrics - included in list price
FR701 (Style 2100)
Anchorage (Style 2977)
Crosstown (Style 5118)
Hatchet (Style 2526)
Metallation (Style 2335)
For a full list of Acoustic and Grade A fabric options, visit egan.com/fabrics-and-textiles/

Grade A Fabrics
Manner (466177)
Metric (466914)
Muse (466487)
Meld (466387)
Murmur (466446)
For a full list of Acoustic and Grade A fabric options, visit egan.com/fabrics-and-textiles/

HOW TO ORDER

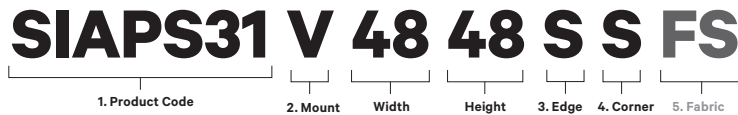

Decorative Tack Panel

Decorative Tack Panel can be used as a tackable surface or purely visual piece adding color, texture, and added STC to a room. Conference rooms, classrooms, offices and hospital patient rooms are just a few perfect applications for these panels.

1/2" Panel Thickness (Base list price Standard Fabric)

Inches	12"	18"	24"	30"	36"	42"	48"
12"	\$140	\$153	\$168	\$181	\$195	\$213	\$227
18"	\$153	\$173	\$192	\$213	\$232	\$255	\$277
24"	\$168	\$192	\$218	\$247	\$276	\$302	\$326
30"	\$181	\$213	\$247	\$279	\$315	\$345	\$376
36"	\$195	\$232	\$276	\$315	\$403	\$444	\$481
42"	\$213	\$255	\$302	\$345	\$444	\$536	\$576
48"	\$227	\$277	\$326	\$376	\$481	\$576	\$624
54"	\$242	\$297	\$352	\$445	\$534	\$624	\$678
60"	\$279	\$344	\$408	\$513	\$629	\$728	\$787
66"	\$318	\$386	\$460	\$579	\$703	\$826	\$891
72"	\$329	\$408	\$494	\$621	\$739	\$874	\$949
78"	\$350	\$424	\$523	\$650	\$787	\$918	\$995
84"	\$386	\$474	\$568	\$715	\$870	\$1007	\$1092
90"	\$428	\$518	\$621	\$782	\$942	\$1100	\$1187
96"	\$442	\$536	\$645	\$811	\$976	\$1141	\$1239
102"	\$502	\$615	\$770	\$882	\$1053	\$1192	\$1292
108"	\$526	\$634	\$795	\$913	\$1094	\$1242	\$1347
114"	\$537	\$652	\$821	\$949	\$1129	\$1283	\$1396
120"	\$552	\$674	\$858	\$976	\$1168	\$1326	\$1442

1/2" Panel Thickness (Base list price Grade A Fabric)

Inches	12"	18"	24"	30"	36"	42"	48"
12"	\$225	\$238	\$252	\$265	\$280	\$298	\$312
18"	\$238	\$257	\$277	\$298	\$317	\$340	\$362
24"	\$252	\$277	\$302	\$332	\$361	\$386	\$411
30"	\$265	\$298	\$332	\$364	\$399	\$430	\$461
36"	\$280	\$317	\$361	\$399	\$524	\$565	\$602
42"	\$298	\$340	\$386	\$430	\$565	\$657	\$697
48"	\$312	\$362	\$411	\$461	\$602	\$697	\$745
54"	\$376	\$431	\$486	\$579	\$668	\$759	\$812
60"	\$413	\$478	\$542	\$647	\$763	\$862	\$921
66"	\$452	\$520	\$594	\$713	\$838	\$960	\$1025
72"	\$477	\$556	\$641	\$769	\$886	\$1022	\$1096
78"	\$497	\$572	\$670	\$798	\$935	\$1065	\$1143
84"	\$533	\$622	\$715	\$862	\$1017	\$1154	\$1240
90"	\$589	\$680	\$783	\$944	\$1104	\$1262	\$1349
96"	\$604	\$697	\$807	\$973	\$1138	\$1302	\$1401
102"	\$663	\$776	\$931	\$1044	\$1215	\$1354	\$1454
108"	\$714	\$822	\$983	\$1101	\$1282	\$1430	\$1535
114"	\$725	\$840	\$1009	\$1137	\$1317	\$1471	\$1584
120"	\$740	\$862	\$1046	\$1164	\$1356	\$1514	\$1630

Custom sizes available - Select next larger size and add \$150 to list / item
 Custom Fabric Upcharge: \$150 List handling fee. Customer required to purchase fabric.

1. PRODUCT CODE

Code	Description
SIDT	Decorative Tack Panel

3. EDGE DETAIL

Code	Description
S	Square

2. MOUNTS

Mount Option	Price	Code
Z-Clip	Add 5% - \$55 min	Z
Impaling Clip	Spot Quote - Call CS	I
Velcro	Spot Quote - Call CS	V

4. CORNER DETAIL

Code	Description
S	Square

5. FABRIC

Acoustic Fabrics - included in list price
FR701 (Style 2100)
Anchorage (Style 2977)
Crosstown (Style 5118)
Hatchet (Style 2526)
Metallation (Style 2335)
For a full list of Acoustic and Grade A fabric options, visit egan.com/fabrics-and-textiles/

Grade A Fabrics
Manner (466177)
Metric (466914)
Muse (466487)
Meld (466387)
Murmur (466446)
For a full list of Acoustic and Grade A fabric options, visit egan.com/fabrics-and-textiles/

RATINGS

NRC Rating	STC Rating
.35	25

HOW TO ORDER

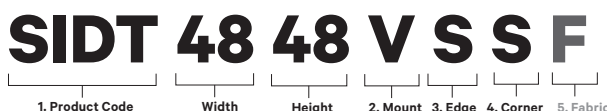

Lecterns

Technology

Egan's technology lecterns blend contemporary design with logical technology management. Our lecterns inspire confidence and give you control of your presentation without the need for a mouse, remote or keyboard. Our lecterns range in features and benefits such as dynamic height adjustment, interactive touch screens, and customizable design specifications.

Contemporary

These elegant lecterns are built for a range of benefits, such as easy mobility, height adjust-ability, as well as ample and lockable storage. These lecterns are built for durability, are light weight and known for their portability. These Contemporary lecterns are popular for modern business presentations, school presentations, art shows, and any setting that calls for an attractive looking presentation.

Classic

Like our Contemporary lecterns, Egan Classic lecterns are designed for settings that call for an attractive looking presentation. These lecterns are popular for customer's choice in wood surface finish and custom printed graphics. Our classic lecterns are also known for their range of features, such as mobility and height adjust-ability.

How to Choose an Egan Lectern

Egan Visual offers an exceptional array of lecterns and presentation centers for any environment that calls for spoken presentations and focused information sharing. Our lecterns range from the beautiful and highly practical AVA Lectern with its endless standard configurations to our attractive and technologically sophisticated TecTern™ Series.

Here are some things to keep in mind when considering which Egan lectern is right for your space:

Esthetic

- Does your space require a Classic, Contemporary or a Technology lectern design?
- Is there a requirement for custom logos or graphics on the modesty facing or any other part of your Egan lectern?
- What finishes does your design palette call for?

The Presenter

- Is it important that your Egan lectern is height adjustable and/or ADA/barrier free for accessibility and comfort?
- Is it preferable that your Egan lectern include hand placement channels on the crown for the speaker's comfort?
- Do you expect a variety of media and presentation methods to be deployed from your Egan lectern (eg: printed notes, projection/document camera)

Utility

- Will your presenters be using a laptop, tablet, or other device to deliver their message be installed in or around your Egan lectern?
- Does your environment require that your Egan lectern be fully mobile and able to move easily from area to area with locking casters?
- Are there any number of audio-visual components that need to be added to your Egan lectern at the time of installation? (eg: racked equipment, room control components)

Places

Egan lecterns can be used to stand out in a variety of places and situations, including: boardrooms, project rooms, lecture halls, places of worship, banquet halls, and hotels. They are also ideal for valets and maître d's to greet guests. You can use your Egan lectern for whatever the situation calls for; the only limit is your creativity.

Everything you see in the following section of this Egan Price & Specification Guide is available as a standard product, a custom configured product with a host of elements to choose from, as well as fully bespoke lecterns and presentation centers that can be designed in partnership with you and our factory experts through our industry leading Custom Response Program.

Audio Visual Height Adjustable Lectern

The AVA lectern is a height-adjustable podium with an elegant, modern design. Finished in wood veneer and powder-coated base and top, the AVA lectern comes with various key features to support you through your presentations. Some key features include a power height adjustment from 31-1/2" to 42-3/8," built-in wheels on base for mobility, pull-out shelf, and a 1 3/4" diameter holes for cabling, monitor arm, microphone restraint or in/out cabling. ADA Compliant.

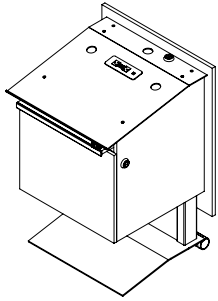

Dimensions	Price
Upper Position: 42 1/8"h to 27 1/2"w	\$11 837
Lower Position: 31 1/2"h to 27 1/2"w	
Worksurface: 25 1/4"l x 27 1/2"w	
Inside Clearance: 17 1/2"h x 16 3/4"w	

1. PRODUCT CODE

Code	Description
AVA	AVA Lectern

2. BODY FINISH

Light Oak	Medium Oak	Dark Oak	Black Oak	Cherry	Mahogany	Natural Maple	Walnut
LO	MO	DO	BO	CH	MA	MP	WA

Custom Stain available - Add \$250 to list, per item

3. TOP, FRAME & BASE

White	Grey	Black
WH	GR	BL

4. OPTIONS

Code	Description	Price
RS	AV Rack and Adjustable Shelf	\$270

HOW TO ORDER

AVA MO BL

1. Product Code 2. Body Finish 2. Finish

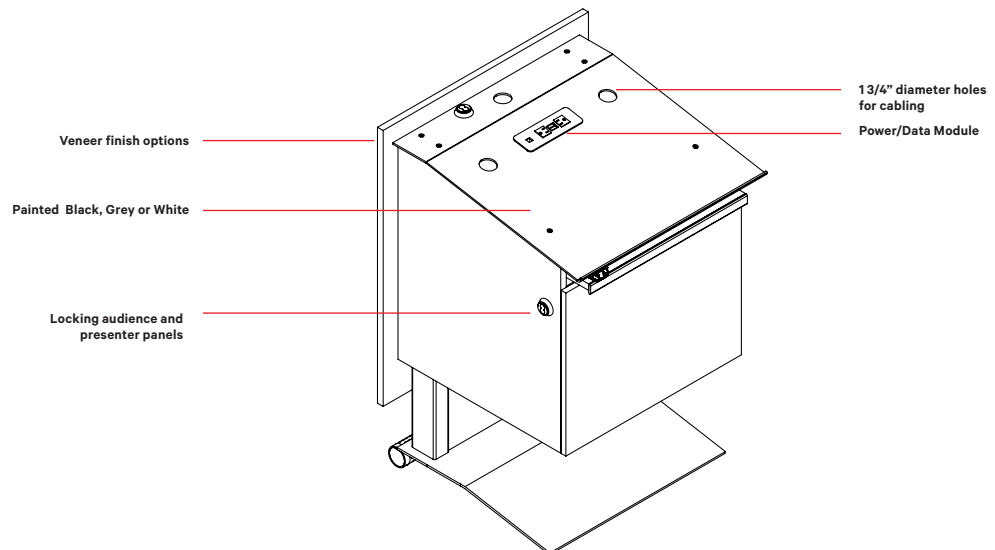

TecTern™ III

TecTern™ III brings a decidedly modern and sleek esthetic to the Egan technology lectern series. With soaring lines and swooping expanses of clean space, TecTern III makes an intelligent statement about the presenter and the presentation. Interactive presentations are easy, with a fully-integrated interactive flat panel - finger touch control that even guest presenters can use, because it connects to the PC with no drivers to install. T3TM includes annotation software.

Description	Dimensions	Price
TecTern III with laptop shelf.	24 5/8"w x 43 3/4"h x 25 9/16"d	\$4 370
TecTern III with Finger Touch Monitor.	24 5/8"w x 43 3/4"h x 25 9/16"d	\$7 950

Monitor has a limited 90 day warranty, including back light

1. PRODUCT CODE

Code	Description
T3LS	TecTern III with laptop shelf.
T3TM	TecTern III with Finger Touch Monitor.

2. WORK SURFACE & BODY FINISH

Code	Description	
WH ¹	White (non-textured) - White Etex Work Surface	¹ Default finish Standard: Locks on presenter side cabinet doors, casters, 19" industry standard AV rack with one shelf Custom color not available
GM	Gunmetal Gray (textured) - Charcoal Etex Work Surface	
EM	EganMetallic (textured) - EganMetallic Etex Work Surface	
BL	Black (textured) - Black Etex Work Surface	

3. OPTIONS

Code	Description	Price
B	Light - 12" electric goose neck lamp complete with dimmer switch.	\$220
CH	Cup Holder	\$40
T	Clock ¹	\$180

¹ Clock (T) is liquid crystal display with front control buttons. The clock is flush mounted. Battery included.

HOW TO ORDER

T3TM WH CH

1. Product Code

2. Body Finish

3. Options

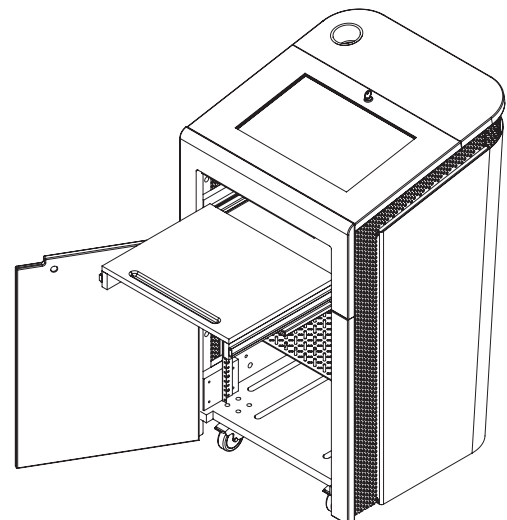
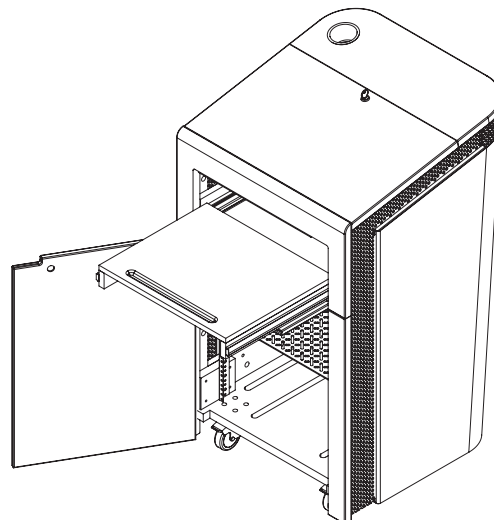

TecTern™ S2

The popular TecTern™ series takes inspiration from the highly customizable 202 series instruction lecterns, bringing high functionality in a contemporary design and modest footprint. TecTern S2 features the size-class of TecTern TWO, but introduces a base and crown that can be specified to your needs. Highly tech friendly, beginning with space for a laptop. Tech is accessible with front and back access panels. At the side, slide out the integrated visualizer deck for comprehensive presentations.

Crown	Lower Cabinet	Price
Etex	Etex	\$3 850
Etex†	Custom Color†	\$4 045
Custom Color 1	Custom Color 1	\$4 045
Custom Color 1	Custom Color 2	\$4 240
Etex	Veneer	\$4 815
Custom Color	Veneer	\$5 010

† Two Custom Colors in any combination
Front and back cabinet door locks, casters, 19" industry standard AV rack with one shelf

1. PRODUCT CODE

Code	Description	Dimensions
S2LS	TecTern S2 with laptop shelf (LS)	24 1/2"w x 44 1/2"h x 23 1/2"d

2. CROWN FINISH

Etex Finish

EganMetallic	Black	Charcoal	Gray	Platinum	Putty	Sand	Slate	Taupe
EM	BL	CL	GR	PT	PY	SN	SL	TA

3. BODY FINISH

Etex Finish

EganMetallic	Black	Charcoal	Gray	Platinum	Putty	Sand	Slate	Taupe
EM	BL	CL	GR	PT	PY	SN	SL	TA

Wood Veneer

Light Oak	Medium Oak	Dark Oak	Black Oak	Cherry	Mahogany	Natural Maple	Walnut
LO	MO	DO	BO	CH	MA	MP	WA

Custom Stain available - Add \$250 to list, per item

3. OPTIONS

Code	Description	Price
B	Light - 12" electric goose neck lamp complete with dimmer switch.	\$220
T	Clock ²	\$180
M	Audience facing digital monitor	\$980

² Liquid Crystal Display clock with front control buttons. The clock is flush mounted in the top right corner of the crown support. Battery included.

HOW TO ORDER

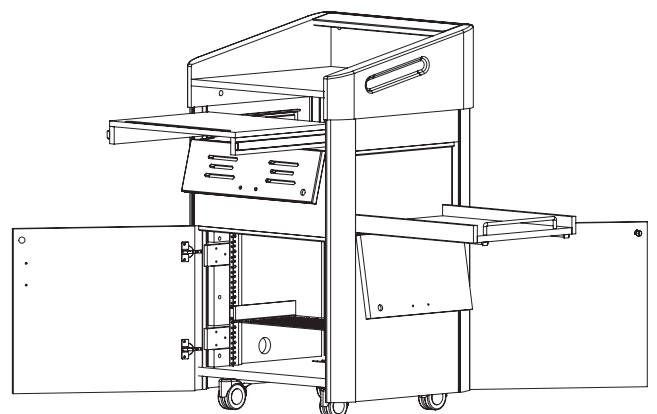
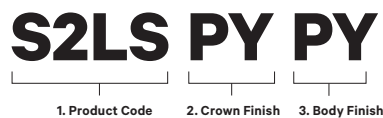

TecTern™ TWO

TecTern™ TWO features the sleek design made popular by TecTern and features a fixed-height crown with ample storage space, laptop tray, storage area with flip-down access panel, drawer, lower cabinet with rails for rack-mounted equipment and a shelf for non-racked equipment. TM model features a VGA adapter. TecTern TWO adds functionality to make your presentations come alive with digital annotations and more, all with the touch of a finger. T2TM includes annotation software.

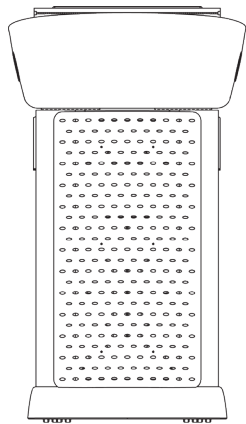

Front

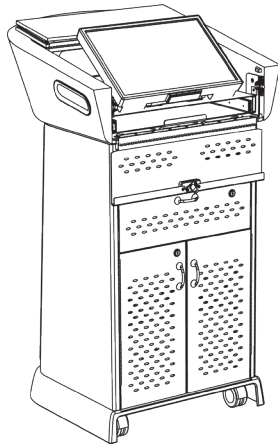

Back

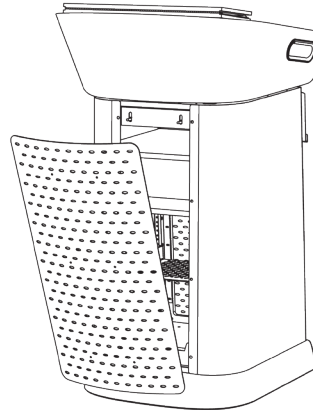

Front Access

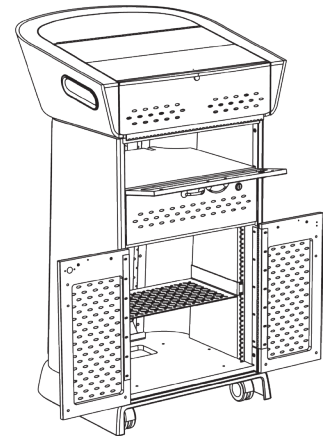

Back Access

1. Choose your Technology Package

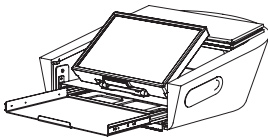
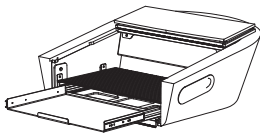

Code	Description	Dimensions	Price
T2LS	Laptop Shelf (LS)	27 1/2"w x 47"h x 25"d	\$6 720
T2TM	Finger Touch Monitor* (TM)		\$10 250

* Ships with annotation software. Monitor has a limited 90 day warranty, including back light

2. Choose TecTern Crown Color

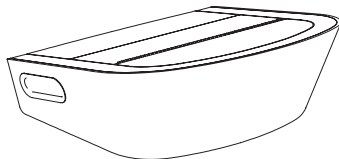

EganMetallic	Black	Charcoal	Gray	Platinum
EM	BL	CL	GR	PT

Putty	Sand	Slate	Taupe	Custom Color
PY	SN	SL	TA	CC

3. Chassis Color*

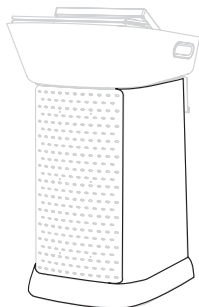

*Chassis Color is standard Gunmetal

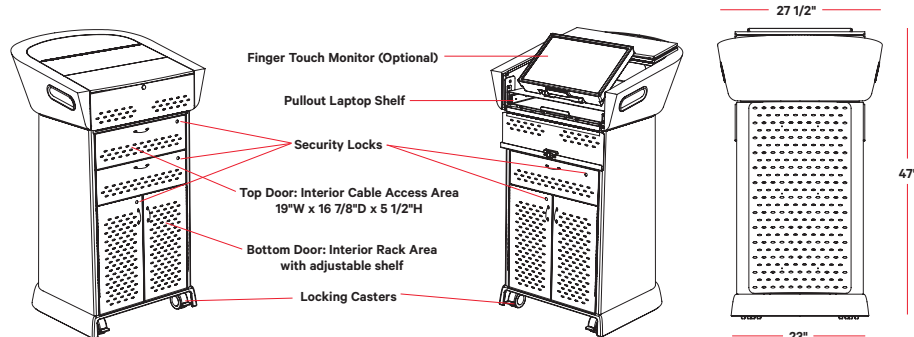

TecTern™ TWO

4. Facing Panel Options

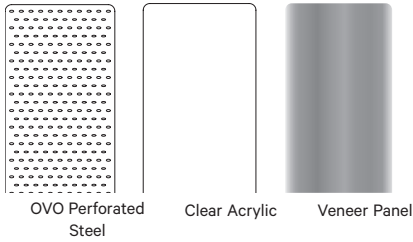

OVO Perforated Steel Clear Acrylic Veneer Panel

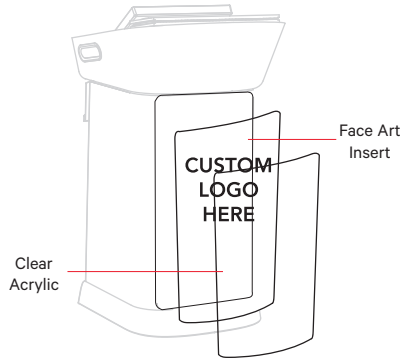

Code	Description	Price
OV	OVO Perforated Steel	\$0
AC	Clear Acrylic*	\$310
VP	Veneer Panel	\$600

* May be paired with Modesty Face Art insert

OV and AC Modesty Facing Finish Color

EganMetallic	Black	Charcoal	Gray	Platinum
EM	BL	CL	GR	PT

Putty	Sand	Slate	Taupe	Custom Color
PY	SN	SL	TA	CC

\$150 per color if Custom Color (CC) option selected

Veneer Modesty Face Finish

Classic Veneer				Modern Veneer
Light Oak	Medium Oak	Dark Oak	Black Oak	Gray Oak
LO	MO	DO	BO	GO

Cherry	Mahogany	Natural Maple	Walnut
CH	MA	MP	WA

\$250 per color if Custom Stain (CS) option selected

5. Facing Art Insert



Code	Description	Price
G	Custom art (EganINK) printed to fit 17" x 32" AC Front Facing Required	\$460

Not available with Veneer Panel Option

6. Light, Optional



Code	Description	Price
B	Light - 12" electric goose neck lamp complete with dimmer switch.	\$220

7. Custom Logo Options

Code	Description	Price
T	Custom Logo, 3D installed or custom built	Call Inside Sales

Your Code Is



TecTern
TWO Lectern
Technology
Integration

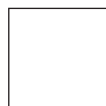

Crown Color



Facing Panel
Option

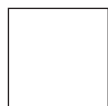

Modesty
Facing Finish
Color



Veneer Panel
Finish



Front Facing
Art Insert



Light

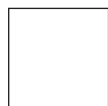

Custom Logo

NOTE: Custom Color fee \$190 applies per color. Additional use of same color on different components are no charge for subsequent use of same color

Electronically height adjustable for universal access and A.D.A. friendliness, the TecTern™ creates opportunities for exciting presenter-audience interaction. Features include an optional built-in finger-touch monitor that allows you to control your presentation directly from TecTern. Interactive presentations are now possible in lecture halls, theatres, and other large-audience settings. TecTern adds functionality to make your presentations come alive with digital annotations and more, all with the touch of a finger. TLTM includes annotation software.

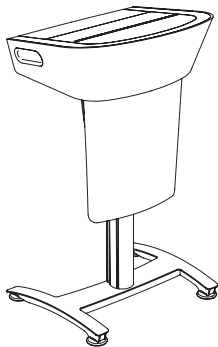

TecTern with Laptop Shelf

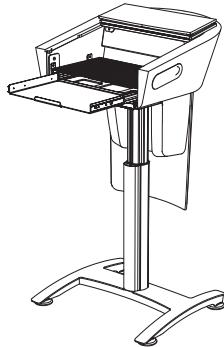

TecTern with Finger Touch Monitor

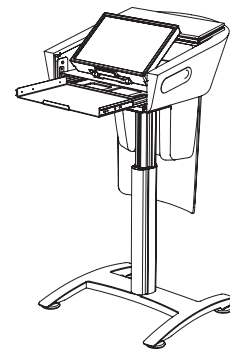
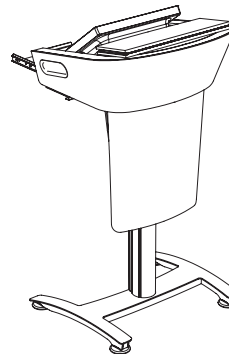

1. Choose your Technology Package

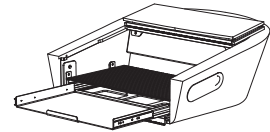
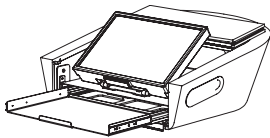

Code	Description	Dimensions	Price
TLLS	Laptop Shelf (LS)	29 1/4"w x 39"h (min) / 51"h (max) x 26 5/8"d	\$7 130
TLTM	Finger Touch Monitor* (TM)		\$11 010

* Ships with annotation software. Monitor has a limited 90 day warranty, including back light. Electric lift motor has a one-year warranty

2. Choose TecTern Crown Color

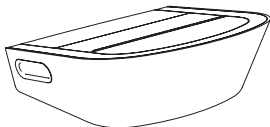

EganMetallic	Black	Charcoal	Gray	Platinum
EM	BL	CL	GR	PT
Putty	Sand	Slate	Taupe	Custom Color
PY	SN	SL	TA	CC

\$250 per color if Custom Color (CC) option selected

3. Choose Modesty Panel / Cable Manager Color

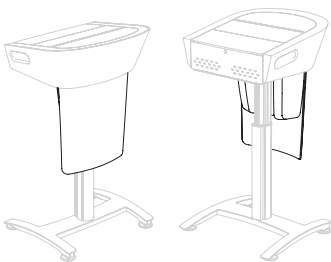

EganMetallic	Black	Charcoal	Gray	Platinum
EM	BL	CL	GR	PT
Putty	Sand	Slate	Taupe	Custom Color
PY	SN	SL	TA	CC

\$250 per color if Custom Color (CC) option selected

4. Modesty Facing Options

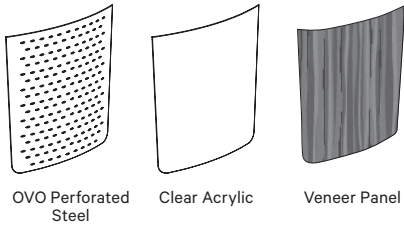

OVO Perforated Steel Clear Acrylic Veneer Panel

Code	Description	Price
OV	OVO Perforated Steel	\$415
AC	Clear Acrylic*	\$310
VP	Veneer Panel	\$600
BP	Basic Panel, No Facing	\$0

* May be paired with Modesty Face Art insert

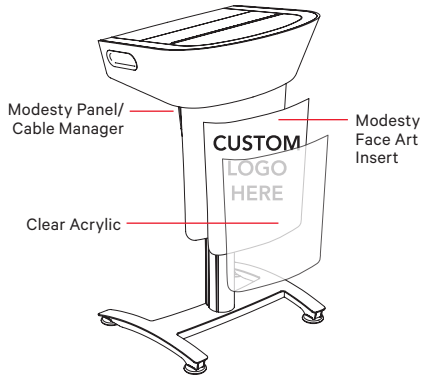

EganMetallic	Black	Charcoal	Gray	Platinum
EM	BL	CL	GR	PT

Putty	Sand	Slate	Taupe	Custom Color
PY	SN	SL	TA	CC

\$250 per color if Custom Color (CC) option selected

Veneer Modesty Face Finish

Classic Veneer

Light Oak	Medium Oak	Dark Oak	Black Oak
LO	MO	DO	BO

Modern Veneer

Gray Oak
GO

Cherry	Mahogany	Natural Maple	Walnut
CH	MA	MP	WA

\$250 per color if Custom Stain (CS) option selected

5. Modesty Facing Art Insert



Code	Description	Price
G	Custom art (EganINK) printed to fit 17 1/2" x 21 1/2" AC Modesty Facing Required	\$460

Not available with Veneer Panel Option.

6. Light, Optional



Code	Description	Price
B	Light - 12" electric goose neck lamp complete with dimmer switch.	\$220

7. Custom Logo Options

Code	Description	Price
T	Custom Logo, 3D installed or custom built	Call Customer Service.

Your Code Is



TecTern Lectern Technology Integration



Crown Color



Modesty Panel/Cable Manager color



Modesty Facing Material



Modesty Facing Finish Color



Veneer Panel Finish



Modesty Facing Art Insert



Light



Custom Logo

202 EganLectern

The Classic 'Front of House' lectern updated with the 202 design. Aluminum extrusions frame your choice of real wood veneer or durable Etex finish. Lockable storage and wiring grommets for field set-up of laptops, tablets and microphone. A 17° angled surface with a lip on the bottom is suitable for reference notes. Two casters on the presenter's side assure the lectern can only be moved by tipping the unit onto the casters. This design prevents 'run-away' when you lean upon the lectern.

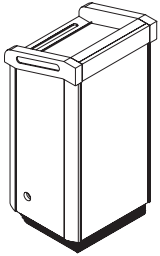

Crown	Lower Cabinet	S2LF Price	
Etex	Etex	\$2 750	Lower cabinet with lock and adjustable shelf 13/4" ID.
Etex	Custom Color	\$2 945	
Custom Color 1	Custom Color 1	\$2 945	Grommets on both sides and top worksurface
Custom Color 1†	Custom Color 2†	\$3 140	
Etex	Veneer	\$3 815	Finish Options: Model may be specified with different finish combinations.
Custom Color	Veneer	\$4 010	

† Two Custom Colors in any combination

1. PRODUCT CODE

Code	Description	Dimensions
S2LF	202 Egan Lectern	24"w x 48"h x 21"d

2. CROWN FINISH

Etex Finish

EganMetallic	Black	Charcoal	Gray	Platinum	Putty	Sand	Slate	Taupe
EM	BL	CL	GR	PT	PY	SN	SL	TA

3. BODY FINISH

Etex Finish

EganMetallic	Black	Charcoal	Gray	Platinum	Putty	Sand	Slate	Taupe
EM	BL	CL	GR	PT	PY	SN	SL	TA

Wood Veneer

Light Oak	Medium Oak	Dark Oak	Black Oak	Cherry	Mahogany	Natural Maple	Walnut
LO	MO	DO	BO	CH	MA	MP	WA

Custom Stain available - Add \$250 to list, per item

4. OPTIONS



Code	Price	Description
B	\$220	Light - 12" electric goose neck lamp complete with dimmer switch.
T	\$180	Clock - Liquid Crystal Display clock with front control buttons. The clock is flush-mounted in the top right corner of the crown support. Battery included.

HOW TO ORDER

S2LF PT PT BT

1. Product Code 2. Crown Finish 3. Body Finish 4. Options

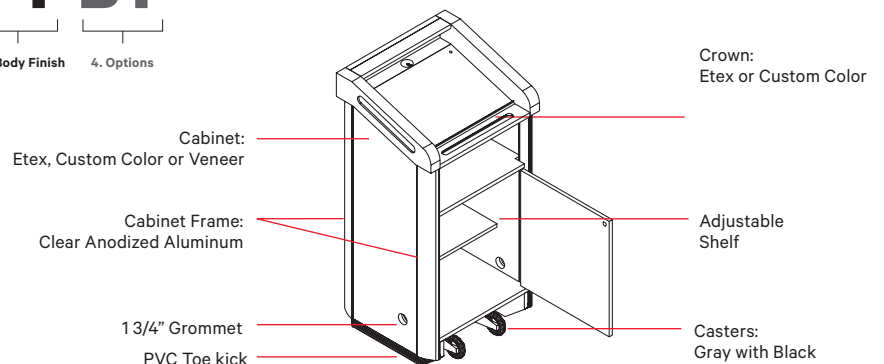

202 Mobile Instruction Center

202 Mobile Instruction Centers are technology-driven lecterns, well suited for specialized requirements. Shelf space accommodates computers and other presentation media equipment. A large drawer accommodates document cameras or overhead/data projectors.

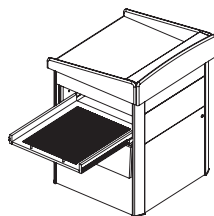

Crown	Lower Cabinet	Price	
Etex	Etex	\$6 210	Aluminum extrusion "bumper" corners to help prevent damage when moving Large worksurface provides ample space for a monitor/ reference material The front panel opens for access to two, supplied 6-outlet powerstrips An articulating arm supports a keyboard and mouse pad Worksurface: 32"w x 25"d Drawer: 23 1/4"w x 8 1/4"h x 27"d Equipment Storage Area: 26"w x 20"h x 28"d (with 2 adjustable shelves) Grommets located on upper crown facing and bottom shelf with 2 1/4" ID
Etex	Custom Color	\$6 405	
Custom Color 1	Custom Color 1	\$6 405	
Custom Color 1†	Custom Color 2†	\$6 600	
Etex	Veneer	\$8 460	
Custom Color	Veneer	\$8 660	

† Two Custom Colors in any combination

1. PRODUCT CODE

Code	Description	Dimensions
S2IM	202 Mobile Instruction Center	34"w x 47 1/2"h x 32 1/2"d

2. CROWN FINISH

Etex Finish

EganMetallic	Black	Charcoal	Gray	Platinum	Putty	Sand	Slate	Taupe
EM	BL	CL	GR	PT	PY	SN	SL	TA

3. BODY FINISH

Etex Finish

EganMetallic	Black	Charcoal	Gray	Platinum	Putty	Sand	Slate	Taupe
EM	BL	CL	GR	PT	PY	SN	SL	TA

Wood Vener

Light Oak	Medium Oak	Dark Oak	Black Oak	Cherry	Mahogany	Natural Maple	Walnut
LO	MO	DO	BO	CH	MA	MP	WA

Custom Stain available - Add \$250 to list, per item

4. OPTIONS



Code	Price	Description
B	\$220	Light - 12" electric goose neck lamp complete with dimmer switch.
T	\$180	Clock - Liquid Crystal Display clock with front control buttons. The clock is flush-mounted in the top right corner of the crown support. Battery included.

HOW TO ORDER



To specify S2IM with multiple finishes or colors please note:

- Both Crown (Top) and body require finish specifications
- Crown is available in Etex and Custom Color only
- Body (Base) is available in Etex, Custom Color, Wood Veneer and Custom Stain
- For Custom Color, specify your desired color
- Custom Color Plus is available on this product
- Custom applications of this product are very popular; see Custom Response (page 13)

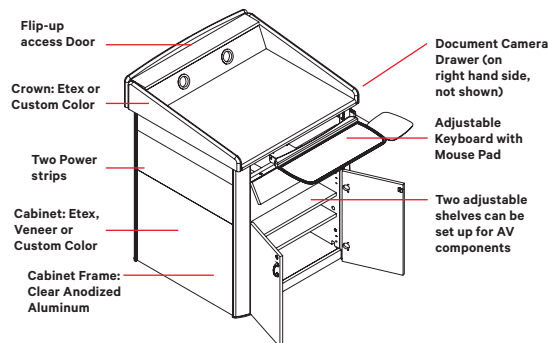

202 ADA

Height-adjustable 202 ADA Lectern is equipped with a push button, electric-lift mechanism that adjusts the working height 34"-44". Inside clearance accommodates wheelchair access and complies with universal design and the Americans with Disabilities Act. Wiring grommets for field setup of laptops, tablets and microphone.

1. PRODUCT CODE

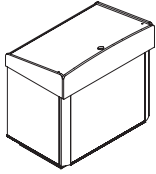

Code	Dimensions
S2LH	Upper-Height Position: 39"w x 44"h x 25"d
	Lower-Height Position: 39"w x 34"h x 25"d
	Worksurface: 38"w x 24"d
	Inside Clearance: 30"w x 24"d

2" locking casters for easy mobility
 Electric lift motor has a one-year warranty
 Aluminium extrusion "bumper" corners help prevent damage when moving

Crown	Lower Cabinet	S2LH Price
Etex	Etex	\$7 795
Etex	Custom Color	\$7 990
Custom Color 1	Custom Color 1	\$7 990
Custom Color 1*	Custom Color 2*	\$8 185
Etex	Veneer	\$9 170
Custom Color	Veneer	\$9 365

* Two Custom Colors in any combination

2. CROWN FINISH

Etex Finish

EganMetallic	Black	Charcoal	Gray	Platinum	Putty	Sand	Slate	Taupe
EM	BL	CL	GR	PT	PY	SN	SL	TA

3. BODY FINISH

Etex Finish

EganMetallic	Black	Charcoal	Gray	Platinum	Putty	Sand	Slate	Taupe
EM	BL	CL	GR	PT	PY	SN	SL	TA

Wood Veneer

Light Oak	Medium Oak	Dark Oak	Black Oak	Cherry	Mahogany	Natural Maple	Walnut
LO	MO	DO	BO	CH	MA	MP	WA

Custom Stain available - Add \$250 to list, per item

4. OPTIONS



Code	Price	Description
B	\$220	Light - 12" electric goose neck lamp complete with dimmer switch.
T	\$180	Clock - Liquid Crystal Display clock with front control buttons. The clock is flush-mounted in the top right corner of the crown support. Battery included.

HOW TO ORDER

S2LH PT MP BT

1. Product Code 2. Crown Finish 3. Body Finish 4. Options

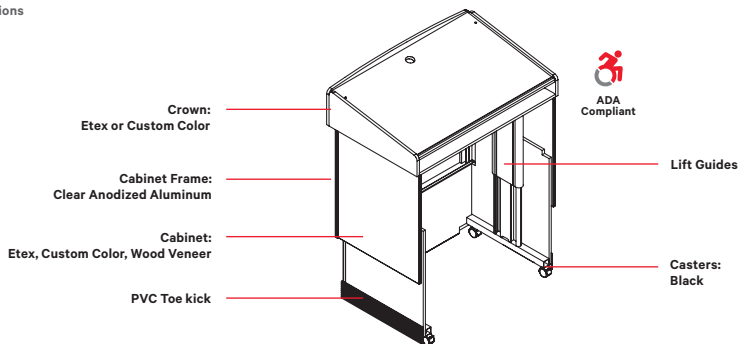

OVO

Egan's commitment to design is showcased in this exciting aluminum lectern. Soft rubber grips keep the presenter firmly connected to their presentation. The document platform is an angled surface with a lip at the front and is suitable for reference notes, includes soft rubber grips, and is height-adjustable 37" h–40" h. Adjusts to horizontal for laptop use. The perforated steel front available in any of our Smooth Etex finishes. The front panel is available in wood veneer.

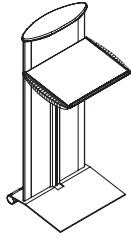

Dimensions	Etex	Veneer	
22 1/2" w x 49" h x 21" d	\$3 230	\$3 550	Document Shelf: Angled 19" w x 15" d with lip to keep notes in place Below Shelf Storage: 13" w x 4" d (reduces to 1" d at front) Height-adjustable document platform adjusts from 37" h to 40" h Document Platform, Crown and Casters finished black only

1. PRODUCT CODE

Code	Description
OVLW	OVO Lectern

2. FINISH

Etex Finish

EganMetallic	Black	Charcoal	Gray	Platinum	Putty	Sand	Slate	Taupe
EM	BL	CL	GR	PT	PY	SN	SL	TA

Smooth Etex finish is available only on perforated front panel. Solid back panel is black only

Wood Veneer

Light Oak	Medium Oak	Dark Oak	Black Oak	Cherry	Mahogany	Natural Maple	Walnut
LO	MO	DO	BO	CH	MA	MP	WA

Custom Stain available - Add \$250 to list, per item

3. OPTIONS

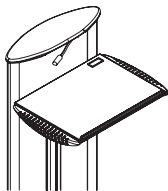

Code	Price	Description
B	\$220	Light - 6" electric goose neck lamp complete with dimmer switch.
T	\$180	Clock - Liquid Crystal Display clock with front control buttons. The clock is flush-mounted in the top right corner of the crown support. Battery included.
PS	\$110	Power Strip - The PowerStrip has 6 outlets with a 4' cord. Mounts in the back of the document platform storage area.

HOW TO ORDER

OVLW CL BTPS

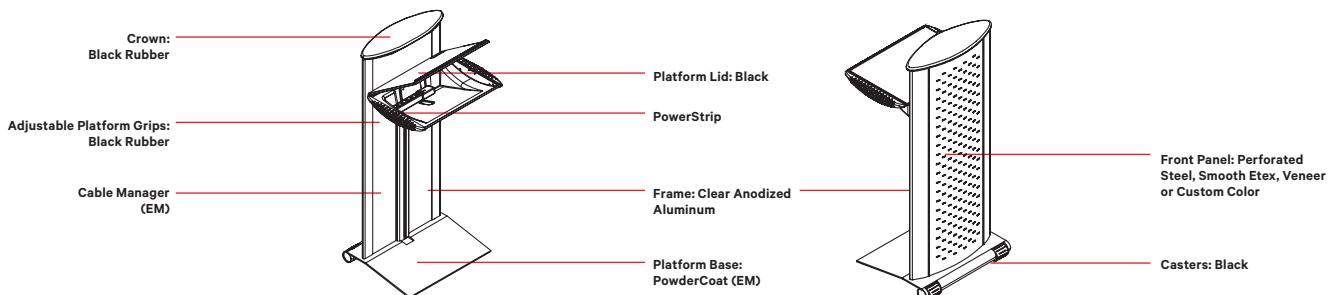

Wood Veneer EganLectern

The Classic 'Front of House' lectern in your choice of real wood veneers. Two casters on the presenter's side assure the lectern can only be moved by tipping the unit onto the casters (prevents 'run-away' when you lean upon the lectern). Lockable storage and wiring grommets for field set-up of laptops, tablets and microphone. A 17° angled surface with a lip on the bottom is suitable for reference notes.

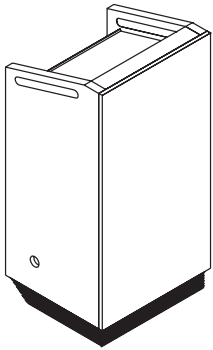

Dimensions	Wood Veneer	
24"w x 48"h x 21"d	\$4 350	Dimensions: Document Shelf: 21 3/4"w x 12"d Upper Storage: 20"w x 8 1/2"h x 17"d Lower Cabinet: 22"w x 22"h x 17"d Lower cabinet with lock to secure electronic equipment Lower cabinet with lock and adjustable shelf

1. PRODUCT CODE

Code	Description
LCLF	Wood Veneer Egan Lectern

2. FINISH

Light Oak	Medium Oak	Dark Oak	Black Oak	Cherry	Mahogany	Natural Maple	Walnut
LO	MO	DO	BO	CH	MA	MP	WA

Custom Stain available - Add \$250 to list, per item

3. OPTIONS



Code	Price	Description
B	\$220	Light - 12" electric goose neck lamp complete with dimmer switch.
T	\$180	Clock - Liquid Crystal Display clock with front control buttons. The clock is flush-mounted in the top right corner of the crown support. Battery included.

HOW TO ORDER

LCLF MP BT

1. Product Code 2. Finish 3. Options

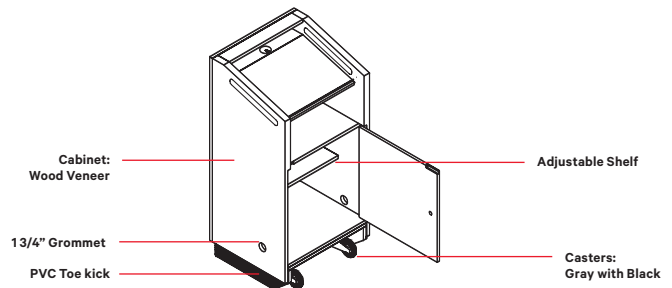

Specify finish followed by options, as shown in sample code below
Veneer finish only, for Etex finish, see 202 EganLectern

Wood Veneer ADA

Height-adjustable, real wood veneer ADA Lectern is equipped with a push button electric-lift mechanism that adjusts the working height 34"-44". Inside clearance accommodates wheelchair access and complies with universal design and the Americans with Disabilities Act. Wiring grommets for field setup of laptops, tablets and microphone.

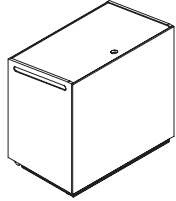

Dimensions	Wood Veneer	
Upper Position: 37 3/4"w x 44"h x 24"d	\$9 250	The electric-lift motor has a one-year warranty 2" locking casters for easy mobility
Lower Position: 37 3/4"w x 34"h x 24"d		
Worksurface: 36 1/2"w x 24"d		
Inside Clearance: 30"w x 24"d		

1. PRODUCT CODE

Code	Description
LCLH	Wood Veneer ADA

2. FINISH

Light Oak	Medium Oak	Dark Oak	Black Oak	Cherry	Mahogany	Natural Maple	Walnut
LO	MO	DO	BO	CH	MA	MP	WA

Custom Stain available - Add \$250 to list, per item

3. OPTIONS



Code	Price	Description
B	\$220	Light - 12" electric goose neck lamp complete with dimmer switch.
T	\$180	Clock - Liquid Crystal Display clock with front control buttons. The clock is flush-mounted in the top right corner of the crown support. Battery included.

HOW TO ORDER

LCLH MP BT

1. Product Code 2. Finish 3. Options

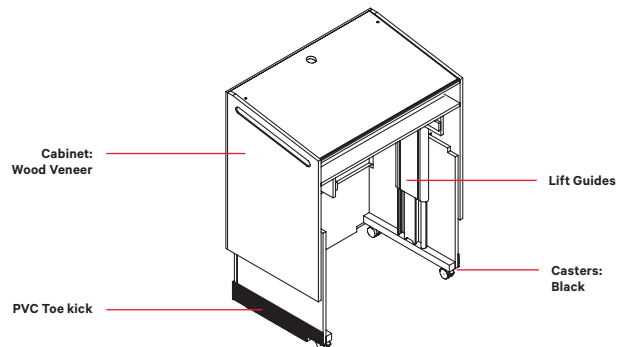

Specify finish followed by options, as shown in sample code below.

Accessories

Take dry-erase, guaranteed-to-clean EVS™ surface with you everywhere. VersaPalette™ is a handy, lightweight dry-erase surface with a handy thumbhole for an easy grip, handling, and hanging. With a double-sided EVS surface, VersaPalette may also be used as a simple and quick privacy tablescreen, as well as professional temporary signage and wayfinding.

Standard sizes include Letter, Legal, Wide Legal and Tabloid. VersaPalette is not magnet-compatible. Surface warranty is standard 10 years. Product warranty is 30 days. Damage not covered. Product edge is not dry-erase and not covered under warranty. EganINK™ compatible.

Versa Palette

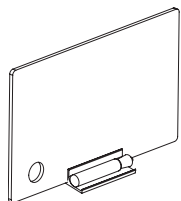

Code	Dimensions	Description	Price
OVPB8X11	8 1/2"w x 11"h	10 pack	\$640
OVPB8X14	8 1/2"w x 14"h	10 pack	\$750
OVPB1114	11"w x 14"h	10 pack	\$840
OVPB1117	11"w x 17"h	10 pack	\$920

VersaPalette Stand

VersaPalette Stand is designed to hold and display your VersaPalette (of any standard size). Use as simple, quick privacy tablescreen, name placard, or temporary signage and wayfinding. Clear Anodized (CA) aluminum finish with a non-skid base. Integrated Marker Tray. Sold in sets of five (5).

Code	Dimensions	Price
OVPS	4 1/2"w stand for VersaPalette. 5-pack.	\$250

HOW TO ORDER

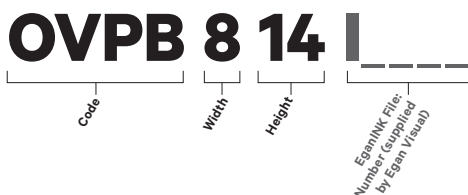

WHAT'S IN THE BOX

- Ten (10) Versa Palette Bundle
- One (1) Versa Palette Stand
- Two (2) assorted color Dry-Erase Markers
- One (1) EganCloth

NOTES

- Sizes cannot be mixed to make a 10-pack
- Custom sizes larger than Tabloid may be available. Call Customer Service to inquire
- Custom shapes are available subject to spot quotation of price, MOQ, and lead time.
- Custom hole location is available subject to spot quotation of price, MOQ, and lead time
- Volume discounting available. Call Customer Service to inquire
- VersaPalette is available in EVS only.
- Standard edge color is light gray. Other edge colors are available under Custom Response program

Trays

EganAero Marker Tray

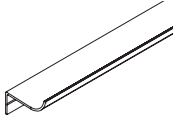

Code	Description	Price
ACEAT12	EganAero Marker Tray. 12"w. 1"d. Ships with two (2) assorted color Dry-Erase markers and one (1) EganCloth.	\$85
ACEAT24	EganAero Marker Tray. 24"w. 1"d. Ships with four (4) assorted color Dry-Erase markers and one (1) EganCloth.	\$125
ACEAT12-12	EganAero Marker Tray. 12"w. 1"d. 12-pack. Ships with twenty-four (24) assorted color Dry-Erase markers and twelve (12) EganCloths.	\$660
ACEAT24-12	EganAero Marker Tray. 24"w. 1"d. 12-pack. Ships with forty-eight (48) assorted color Dry-Erase markers and twelve (12) EganCloths.	\$980

New Egan ONE Tray

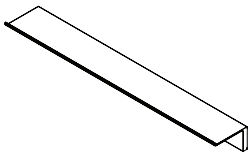

The NEW Egan ONE tray is available with an adhesive mount, for non magnetic surfaces, or a neo-magnet mount, for use with all magnetic surfaces. The 2" deep design accommodates 2 rows of markers and provides an attachment point for the new Egan Cloth.

Code	Description	Dimensions	Price
ACEOT12M	Magnetic Mount	12"w x 1-3/8"h x 2"d	\$160
ACEOT12A	Adhesive Mount	12"w x 1-3/8"h x 2"d	\$160
ACEOT24M	Magnetic Mount	24"w x 1-3/8"h x 2"d	\$180
ACEOT24A	Adhesive Mount	24"w x 1-3/8"h x 2"d	\$180
ACEOT36M	Magnetic Mount	36"w x 1-3/8"h x 2"d	\$210
ACEOT36A	Adhesive Mount	36"w x 1-3/8"h x 2"d	\$210
ACEOT48M	Magnetic Mount	48"w x 1-3/8"h x 2"d	\$230
ACEOT48A	Adhesive Mount	48"w x 1-3/8"h x 2"d	\$230
ACEOT60M	Magnetic Mount	60"w x 1-3/8"h x 2"d	\$270
ACEOT60A	Adhesive Mount	60"w x 1-3/8"h x 2"d	\$270
ACEOT72M	Magnetic Mount	72"w x 1-3/8"h x 2"d	\$280
ACEOT72A	Adhesive Mount	72"w x 1-3/8"h x 2"d	\$280
ACEOT77M	Magnetic Mount	77"w x 1-3/8"h x 2"d	\$290
ACEOT77A	Adhesive Mount	77"w x 1-3/8"h x 2"d	\$290
ACEOT82M	Magnetic Mount	82"w x 1-3/8"h x 2"d	\$310
ACEOT82A	Adhesive Mount	82"w x 1-3/8"h x 2"d	\$310
ACEOT96M	Magnetic Mount	96"w x 1-3/8"h x 2"d	\$330
ACEOT96A	Adhesive Mount	96"w x 1-3/8"h x 2"d	\$330
ACEOT120M	Magnetic Mount	120"w x 1-3/8"h x 2"d	\$380
ACEOT120A	Adhesive Mount	120"w x 1-3/8"h x 2"d	\$380

Custom sizes available

Tray can be mounted through an Adhesive or NeoMagnet mount.

Ships with 2 markers and the EganCloth

Dry-Erase Accessories

A whiteboard is not just a whiteboard when you combine the dust-free whiteboarding materials listed below. Egan's EVS™ surface, Dry-Erase Markers and EganCloth™ provide a guaranteed-to-clean dry-erase solution.

Dry-Erase Markers

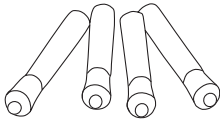

High quality Dry-Erase markers. Assorted colors. One dozen (12).

Code	Description	Price
ACDZ	Assorted color Dry-Erase Markers. Three (3) of each color.	\$45
ACDZGR	Green Dry-Erase Markers.	\$45
ACDZRE	Red Dry-Erase Markers.	\$45
ACDZBLUE	Blue Dry-Erase Markers.	\$45
ACDZBL	Black Dry-Erase Markers.	\$45
ACDZRB	Six (6) Red + six (6) Black Dry-Erase Markers.	\$45

New Magnetic EganCloth

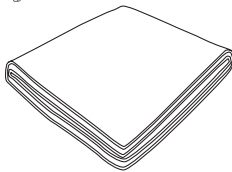

Attracts dry-erase dust like a magnet. No need for special cleaning solutions. Easy to use and clean. Traps dust and grime. Hypo-allergenic and non-abrasive. Integrated neo-magnet that is compatible with all magnetic surfaces. EganCloth is a reusable product. Machine or hand washable. Do not wash with other materials.

Code	Description	Price
EVEC12M	EganCloth (12" x 8") 12-pack	\$130
EVEC24M	EganCloth (12" x 8") 24-pack	\$190

Egan NeoMagnet



Code	Description	Price
ACEAMAG4	Rare-Earth Magnet. 7/8" diameter. 9/16"d. Box of four (4). Assorted color.	\$130

EganMount



The EganMount is a 7/8" x 7/8" steel plate with an adhesive back, which will provide a mounting location for the new Egan Cloth. The EganMount can be installed on boards, walls, and is available in a 10 pack.

Code	Description	Price
ACEM10	EganMount 7/8"x7/8" self adhesive metal logo designed to accept the new magnetic EganCloth on non magnetic surfaces 10-pack	\$115

Grips & Tearbars

EganSystem Track Mount - Friction Grip

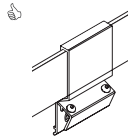

Code	Description	Price
ESFG6	1 1/2"w and holds single flipchart sheets. Available finishes are EganMetallic (EM), Putty (PY), and Charcoal (CL). 6 pack	\$165

- Designed for use with EganSystem 202 Upper Track
- For Custom Color, add 15%. \$145 minimum

EganSystem Track Mount - Variable Tension Grip

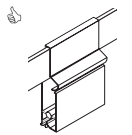

Code	Length	Description	Price
ESVS	3"	Holds paper or Boards up to 1/4" thick. Finishes: EganMetallic (EM), Putty (PY), and Charcoal (CL).	\$75
ESVL	10"		\$95

- Designed for use with EganSystem 202 Upper Track
- For Custom Color, add 15%. \$190 minimum

EganGrip



Display flipchart sheets and more by simply pushing paper up into the gravity-fed roller. To remove sheet, simply curl up and out. Standard finish is brushed Clear Anodized (CA) aluminum.

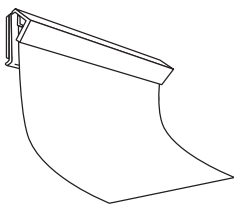

Code	Mount Options					Size
	Magnetic (M)	Adhesive (A)	Plate (P)	Top (T)	System (S)	
G_21.5	\$95	\$95	\$95	\$140	\$150	21 1/2"
G_33.5	\$105	\$105	\$105	\$150	\$160	33 1/2"
G_45.5	\$120	\$120	\$120	\$165	\$180	45 1/2"
G_57.5	\$150	\$150	\$150	\$190	\$200	57 1/2"
G_69.5	\$165	\$165	\$165	\$210	\$225	69 1/2"
G_93.5	\$190	\$190	\$190	\$240	\$250	93 1/2"

- For Custom Color, add 15%. \$190 minimum

Flipcharts, box of 5

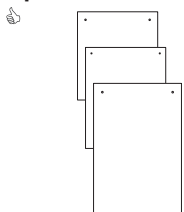

Code	Description	Price
ACFL20225	20"w x 22 1/2"h for 48" x 32" cabinets	\$155
ACFL20305	20"w x 30"h for all other cabinets	\$165
ACFL27345	27"w x 33"h for Flipchart Assembly (EETBFC)	\$250

Fixed Tearbars



Code	Description	Price
ACTBAR	27"w for Flipchart Assembly (EETBFC, EMTBFC)	\$105
ACCBAR	20"w for Flipchart Assembly for EganCabinets (inside door) (CEWR, CARW, CEWB, CABW, CEWT, CATW, CAPX, CEXB, CABX, and CE2)	\$105

Adjustable Flipchart Holder & Tearbar, Magnetic Mount



Code	Description	Price
ACTSTBMG	28" w x 2 1/2" h for EganSystem	\$285

Replacement Projection Screens

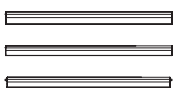

Code	Description	Price
ACSCR4	48" w Cabinets	\$220
ACSCR6	72" w Cabinets	\$250
ACSCRTRPS	Screen for Retractable Track Mount Screens (EMSCR)	\$250

Mount Brackets

Mount Brackets

Code	Description	Price
ACWAL21	21" w Cabinet Wallmount Bracket. For 24" w Cabinets.	\$33
ACWAL32	32" w Cabinet Wallmount Bracket. For 32" w and 48" w Cabinets.	\$33
ACWAL64	64" w Cabinet Wallmount Bracket. For 72" w Cabinets.	\$33
ACWALDIM20	20" w Dimension Cleat. For 2436 Dimension Stele™ Boxcore™ boards and Dimension Tack Boxcore boards with 1-1/8" frame.	\$33
ACWALDIM32	32" w Dimension Cleat. For 4832 Dimension Stele Boxcore Boards and Dimension Tack Boxcore boards with 1-1/8" frame.	\$33
ACWALDIM36	36" w Dimension Cleat. For 4848 Dimension Stele Boxcore and Dimension Tack Boxcore boards with 1-1/8" frame.	\$33
ACWALDIM45	45" w Dimension Cleat. For 6048 Dimension Stele Boxcore and Dimension Tack Boxcore boards with 1-1/8" frame.	\$33
ACWALDIM60	60" w Dimension Cleat. For 7248, 7748 Dimension Stele Boxcore Boards and Dimension Tack Boxcore boards with 1-1/8" frame.	\$33
ACWALMB20	20" w Standard Mount Bracket. For 2436 Presentation Boxcore, Tack Boxcore 3/4" frame and aluminum framed markerboards.	\$33
ACWALMB32	32" w Standard Mount Bracket. For 4832 Presentation Boxcore, Tack Boxcore 3/4" frame and aluminum framed markerboards.	\$33
ACWALMB36	36" w Standard Mount Bracket. For 4848 Boards, Presentation Boxcore, Tack Boxcore 3/4" frame and 4848, 6048, 7248 aluminum framed markerboards.	\$33
ACWALMB45	45" w Standard Mount Bracket. For 72" Cabinets, and 9648 aluminum framed markerboards.	\$33
ACWALMB60	60" w Standard Mount Bracket. For 7248, Presentation Boxcore, Tack Boxcore 3/4" frame.	\$33
ACWALWFMB20	20" w Solid Wood Bracket. For 2436 Wood Frame Boards.	\$33
ACWALWFMB28	28" w Solid Wood Bracket. For 4832 and 3648 Wood Frame Boards.	\$33
ACWALWFMB48	48" w Solid Wood Bracket. For 48" w, 60" w, 72" w, 96" w Wood Frame Boards.	\$33
ACWALWFMB72	72" w Solid Wood Bracket. For 9648 Wood Frame Boards.	\$33
ACWALMB-Z36	36" w Z-Bracket. For 4848, 7248, 6048 Boards, Dimension Stele, Tackable Wings	\$33
ACWALMB-Z45	45" w Z-Bracket. For 6048 Boards, Dimension Stele, Tackable Wings	\$33
ACWALMB-Z60	60" w Z-Bracket. For 7248 Boards, Dimension Stele, Tackable Wings	\$33
ACWALMB-Z72	72" w Z-Bracket. For 9648 Boards, Dimension Stele, Tackable Wings	\$33
ACWALMMB94	94" w Standard Mount Bracket. For 94" multiple horizontal EganMosaic board installations.	\$67

Egan Programs & Services: Overview



*Instant Ship

Instant Ship Program

Instant Ship, In Stock - Quantities up to six (6) are available on two day lead time. Product is shipped within two (2) business days. Instant Ship items can be found on page 2. Delivery subject to receipt of written order and inventory levels at time of order. For critical orders please confirm by calling **1-800-263-2387**.



Freight Included

Freight Included Policy

Qualifying orders ship freight prepaid as a single piece. Any unqualified orders will have freight charges added to the invoice. Freight charges apply on orders under \$3 000 list. See Freight Program (page 92).



GREENGUARD Certification

Egan promotes global sustainability, environmental health, and safety. Our products have low chemical emissions, preserving the quality of the air in which the products are used. GREENGUARD conducts strict chemical emissions tests, and certifies products that meet healthy interior standards.

Download your copy of Egan product GREENGUARD Certificates at www.egan.com.



EcoTack/PET

EcoTack is Polyethylene Terephthalate (PET). The tackable infill material is an adaptable acoustical panel made from 100% polyester - approximately 50% is recycled water bottles. EcoTack features a 3/8" deep tackable panel mounted proud on the board.



Egan Fabric Program

Egan offers a range of Maharam fabric options that can be specified on all Tackable and Sound Ideas products. All available fabrics have been factory tested to ensure it delivers upon the quality and performance that Egan demands of its products. For more information on the Egan fabrics available and for more information on custom fabric options, see page 88 or visit egan.com.

Contact Maharam directly at **1-800-645-3943** or visit www.maharam.com for samples or memos for presentation. For your convenience, digital representations are available online at www.egan.com.

Flammability

Maharam textiles meet all appropriate flammability requirements (further details available, please contact Maharam):

- California Bulletin #117
- Compatible with California Bulletin #133
- Tunnel Test surface ratings
- Class I UFAC



Egan Infinite Color Program

Choose from over 1,000 standard colors at no additional cost. The Infinite Color Program is available on all Egan Glass products - EganAero and GlassWrite. The color program includes Egan Infinite Palette and Pantone colors (uncoated and coated). To view the full range of colors, visit pantone.com or egan.com to download the Infinite Color Palette fan deck at egan.com.



Custom Stain

Egan offers 8 stain options but have the resources in house to match or create a custom stain based on your design. For an additional upcharge of \$250/ product Egan will work with you to give you the stain you need.



EganINK

Enhance Egan products by specifying EganINK. Print on any of the following Egan surfaces: GlassWrite, EganAero, EVS, and Fabric - standard upcharge of minimum \$200 or \$25/sqft. EganINK is perfect for injecting branding, custom graphics, signage or artwork into your space. To learn more about Egan's high quality, large format graphic printing, see page 86.



Custom Response

As a manufacturer, Egan has a wide range of capabilities and resources available to provide a product that is tailored to a customer's specific needs. From simple customizations like logo designs and sizes adjustments to more complex configurations such as new product design, we will work with you at every step of the way. For more information on how to engage Egan and to learn more about our process.

Custom Color & Color Matching



If you do not see the right color in the Infinite Color Program or have a specific color you need to match, Egan Visual offers comprehensive and accurate color matching thanks to our in-house spectrophotometry, color mixing, surface finishing, and know how. Egan color matches the painted surface to a Delta E (dE) of 1.0 which means when comparing the sample swatch and the Egan color matched sample any difference is barely perceivable by the average human eye.

The Custom Color program is limited to color matches that do not have speckles, patterns or any metallic content. Egan uses polymer coatings which may be specified in custom colors. Our color engineers are comfortable with most color industry standard fan decks, such as Sherwin Williams and Benjamin Moore, and using color codes for customer supplied samples.

Egan will match the color specified as closely as our formulating process allows. Please note that color gloss cannot be matched. There is a standard upcharge unless indicated otherwise. Samples are not provided for approval unless requested, additional charges may apply. Finishes outside of these parameters will be addressed on a sample by sample basis and additional charges may be applicable.

There are three easy ways to choose a color

1. Choose a color from the Infinite Color Program: which will include the the Egan Infinite Color Palette or any Pantone color. Egan Infinite Color palette: egan.com/infinite-color-palette/
Pantone colors: <https://www.pantone.com/color-finder>
2. Specify a color from an industry or commercial standard fan deck (RAL, Pantone, Benjamin Moore, Sherwin-Williams, etc.)
3. Supply something that you would like color-matched

Custom Stain



Egan encourages custom stain applications. Our finishing system is automated and ensures that the proper amount of stain and lacquer is sprayed on each product. However, as wood is a natural product, each log will vary in color and appearance. Egan's skilled carpenters match doors and components to enhance the natural and variable beauty of real wood.

All veneers are small heart, center book matched and finished in a fast curing two component lacquer which provides a durable, open-grain silk-matte finish. Veneer is 1/64" - 1/32" thick. Occasional cleaning with any household furniture polish will maintain this finish like new for many years. Customers are responsible for the suitability of the final product. Many modern veneer selections are available through our Custom Response program.

Ordering Custom Stain

1. Provide sample species (Oak, Cherry, Mahogany, Maple and Walnut) with stain applied. Where possible please provide details of stain manufacture, product number, and application details so our crafts people can reproduce the custom stain as accurately as possible within Egan's normal manufacturing process.
2. Egan will produce a sample for review.
3. Egan will require signed approvals with PO. Natural variations are to be expected and are not Egan's responsibility,

Unfinished Wood Products

Unfinished Wood Products may be ordered:

- By specifying wood species required and
- By tagging it "Ship to customer unfinished."

Preparing a product for custom staining requires additional steps to be taken, at no additional cost. Any complaint regarding the quality of a unit must be registered prior to any finish work being performed.

Note: Presentation Cabinets with tackable fabric panel on the inside of each door on any unfinished unit is supplied with paper wrapped around it to protect the fabric from stain during the finishing process. The paper should be carefully removed by cutting around the perimeter with an appropriate blade.

EganINK - High Graphic Printing

Sometimes, creative environments need visual interest or structure to inspire and complete thinking. Bold or understated, EganINK complements and sets the mood, whatever your mood may be – KPI templates, care boards, logos, wayfinding, signage, or high-resolution art. EganINK bespoke graphics may be specified on a wide range of Egan products, whether it be stock art or COA. This is where the ability to customize and introduce your own design to our communication tools is useful.

EganINK is an innovative ink system provides high resolution multi-color application of letters/lines/graphics. EganINK gives you the flexibility to uniquely communicate your message, showcase your brand, and express your ideas. With infinite possibilities for customization with lines, grids, dots, letters, logos, graphics and full-color art, you can create one-of-a-kind charts and collaboration boards that truly inspire. The design intent of EganINK is that it will represent most artwork and logos faithfully at a normal viewing distance, allowing you to have a functional workspace that is in harmony with your corporate identity and the design of the room. GlassWrite and EVS products may be printed with EganINK. EganINK has a limited 1 year warranty.



TEMPLATES & CHARTS



BRANDING



ARTWORK & PHOTOGRAPHY

Custom Response Program



The Custom Response Program is designed to encourage specialized product development. Our manufacturing systems provide for variations and custom solutions. Working with initial direction from designers and clients, Egan will research and develop solutions that work within the Egan manufacturing process. This makes the program ideal for those clients who require a single run of a substantial number of products and/or where there is an ongoing need. Opportunities for complete product design where volume is available are also encouraged.

Our CAD specialists understand high-quality cabinetry and can quickly evaluate Custom Response Program requests. Contact your local Egan Representative with your product needs. Pricing and delivery is based on individual requirements.

Example #1

Original product: V-Series Mobile

Custom product: Customer's Own Panel with customer's slat wall installed 30" from the floor to match desk height.

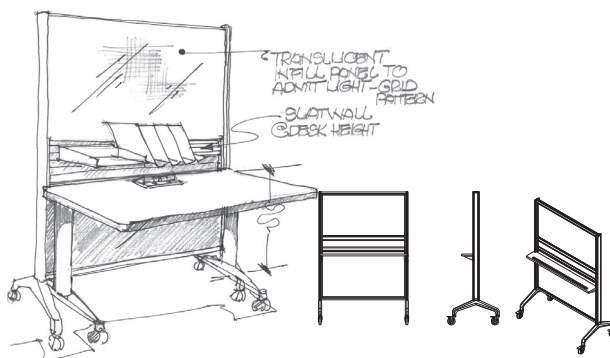

Example #2

Original product: 202 Mobile Instruction Center

Custom product: University Lecture Command Console 42" wide, with monitor and room control touchscreen and AV racking. A popular variation of the S2IM.

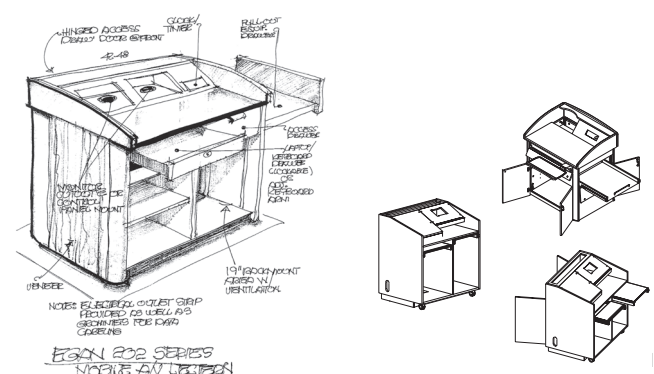

Egan Fabric Program

Egan has tested compatible fabrics with Guilford of Maine (GOM) and Maharam Fabrics. Egan factory tests and approves tackable and acoustical textile designs in two grades. Guilford of Maine is priced at standard while Maharam's M-Series program (excluding Messenger pattern fabric) is available with a small upcharge - the cost is added to the total cost of the specified product and applicable options.

Need Fabric Samples

Egan stocks samples for:

- Egan Fabric
- Maharam Fabric Program Card
- GOM Fabric Program Card

Contact Guilford of Maine directly at **1-800-544-0200** or visit www.guilfordofmaine.com for memo samples.

Contact Maharam directly at **1-800-645-3943** or visit www.maharam.com for memo samples.

For your convenience, digital representations are available online at www.egan.com.

maharam

To place an order please specify:

1. The Maharam fabric number, including color, dye lot (if applicable), name. For example: Maharam Medium Pool 463490-040
2. Based on this information, you can build the Egan product code, including finish and option codes, followed by the textile code as shown below:

CE2 A 6048 MP FL 463490-040



Guilford of Maine

To place an order please specify:

1. The Guilford of Maine fabric number, including color, dye lot (if applicable), name. For example: GOM, FR701 White 2100-224
2. Based on this information, you can build the Egan product code, including finish and option codes, followed by the textile code as shown below:

SIAPS3 1 V 48 48 S R 2100-224



Customer's Own Material (COM)

All Egan tackable components may be ordered with EganFabric Program textiles or with customer-supplied fabrics. Customer's Own Material (COM) handling is priced as \$120 list per order. The cost of textile and delivery are additional costs that are not included in Egan pricing. It is the customer's responsibility to determine if the fabric is appropriate for the application specified and that it meets applicable codes and regulations.

Egan reserves the right to reject fabrics that, in our opinion, would create unsatisfactory results on the intended application with our normal manufacturing methods.

If it is established that the textile selected will compromise the quality or integrity of Egan products, customers are contacted to discuss these concerns.

Egan does not accept responsibility for unsatisfactory results, overall appearance, fabric defects, flammability, normal durability, color fastness or any other quality issue after installation, beyond normal Egan quality standards.

At Egan Visual, we strive to craft superior results. Visit www.egan.com for further details on COM and Egan Fabric Program.

COM Specification for Tackable Panels

1. Customer/Company Name
2. Contact name, phone number and email address
3. Egan product code, correctly specified
4. Fabric sample - indicate face side and pattern direction
Supply a sample securely fastened to order showing pattern direction.
5. Customer purchase order with COM correctly indicated
6. Fabric manufacturer, fabric name, color, code and dye lot
7. Fabric requirements fully specified, including (but not limited to) horizontal/vertical direction, pattern matching, railroading, pattern repeats, reversibility.

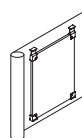

Cut across the roll (known as 'railroading')

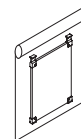

Cut up the roll (typical or normal direction)

8. Visit www.egan.com for COM Product Yardage Requirements.
9. All COM must be sent prepaid to:
Egan Visual
Attention: COM Receiver
300 Hanlan Road
Vaughan, ON L4L 3P6 Canada
10. Label instructions securely applied to COM.

Purchase Order Requirements for Expedited Order Processing

Egan Visual strives to offer quality products at a great price. We value your decision to place your orders with us. In order to promptly acknowledge your orders we need you to supply sufficient and correct information. Please review the guide below.

Sample Purchase Order		
Order Date:		
Purchase Order #		
Vendor: EGAN VISUAL, 300 HANLAN RD., WOODBIDGE, ON, L4L 3P6	Billing: (Company Name) (Address) (City, State, ZIP)	Delivery: (Company Name) (Address) (City, State, ZIP) (F.I.N.)
Egan Acct. #	Egan Acct. Payment Terms:	
Correct Product Information: (Quantity, Item code, Option code, Mounting Option code as applicable)		
Complete: (Product description including wood species, color or fabric numbers as applicable)		
Maharam Tackable Fabric: (Fabric grade [A, B, C], Style #, Name, Color, Description, Upcharge)	Custom Color: (Provide matching system type)	Custom Stain: (Supply sample with purchase order. Include stain manufacturer, stain number or name and base of species)
Customer's Own Material: (Fabric manufacturer, fabric name, color, code and dye lot, fabric requirements fully specified)	VersaJot Electronic File: (Specified as per Price and Specification Guide)	Custom Logo: (Appropriate electronic artwork, specific color details)
Accurate Unit Price + Extended Price + Total Price		
Discount Taken:	Delivery Date:	
		Signature:

FL

Complete P.O. must include...

- P.O. number
- Billing address
- Delivery address
- Delivery Contact Information
- **Note:** A P.O. Box cannot be accepted as a delivery address.

Don't forget...

- F.I.N. for USA delivery addresses only.

Do you have...

Correct and complete product information, including special colors, stains, and fabric options.

Note:
Look for "How To Order This Product" at the bottom of each page.

Include...

Egan quote reference if applicable.

Remember...

Let us know when you need your order and if we can deliver before your expected delivery date.

Double-Check...

Price and discount structure must be correct to ensure immediate processing of your order.

Email confirmations...

Enter buyer's contact name and contact email address.

Cleaning Instructions

EVS: Egan Versa Surface

The high-quality, dry-erase surface EVS cleans so effectively, it even withstands the use of permanent markers.

1. Use EganCloth to trap dry erase dust in the micro-fibers and maintain a clean surface.
2. Remove all dry-erase markings from surface with a clean EganCloth before applying spray glass cleaner such as Windex. Regular cleaning with a recommended spray glass cleaner and an EganCloth will prevent dirt and film buildup, and remove residue, that can impede dry-erase performance.
3. Use isopropyl rubbing alcohol 90% to remove stubborn marks and residue.

*Egan recommends solvent based Dry-Erase Markers (BIC Great Erase Bold) or comparable marker.

GlassWrite

Regularly removing ink, dirt, stains, or grease from fingerprints is the best way to preserve the quality of your glassboard. Take care of your GlassWrite by following the instructions:

1. Typical day to day maintenance should not require any more than cleaning with Windex, or an ammonia base glass cleaner. Care should be taken to avoid glass cleaners with detergents that will leave a residue, which will affect the dry erase characteristics of Egan GlassWrite boards.
2. Wipe the glass until dry using a clean EganCloth or paper towel to remove streaks that may have formed.
3. If any contaminants remain on the glass, 90% isopropyl alcohol can be used to remove it. This works well with sticky or gluey materials and permanent markers.

Fabrics

Maintain the quality and longevity of your fabric board or sound panel by carefully removing dust, dirt, stains and other forms of debris that accumulate overtime.

1. UPHOLSTERY VACUUM OR BRUSH: Lightly brush with a soft brush, or lightly vacuum with an upholstery attachment. Vacuuming will minimize the accumulation of dirt and dust. Do not use high suction commercial vacuum as they may cause damage.
2. A FABRIC FRIENDLY CARPET CLEANER: Most soiled areas can be cleaned using a damp cloth, if there is a stubborn stain, please use a commercially available upholstery or carpet cleaner that can be used on polyester fabric.

Note: If possible, test the selected cleaning agent on a non-visible area of the panel before attempting to clean the soiled area to assure best outcome.

Porcelain

Using an EganCloth with a cleaner - such as warm soapy water, window cleaner or isopropyl rubbing alcohol 90% - is enough to keep a the Porcelain surface clean, if used every week. Dry erase markings and ink stains left on the porcelain surface for weeks or months may require a stronger cleaning solvent to fully remove old writing (isopropyl rubbing alcohol 90% may remove these stains). Remove any cleaning solution residue from the surface with a dry, clean EganCloth to prevent any reactions between solvent residues and inks in dry erase markers. Do not use wax-based cleaners as they will leave a residue on the surface.

*Egan recommends solvent based Dry-Erase Markers (BIC Great Erase Bold) or comparable marker.

Egan Standard Terms & Conditions

Commercial Terms

Overall

Egan Visual Standard Terms & Conditions are subject to change without notice. See www.egan.com for currently prevailing terms. All specifications, pricing, and other information is believed to be accurate at the time of publication (E&OE) but is subject to change without notice. Prices herein are valid in the United States only and are stated in USD. Possession of this document does not constitute an offer to sell.

Cancellations

Orders are considered binding on the Buyer and on Egan, subject to the ICC Force Majeure Clause 2003 or the ICC Hardship Clause 2003. If the Buyer wishes to cancel an order, the decision to accept cancellation lies with Egan and will be governed by its ability to conform. A penalty or service fee may be imposed at the discretion of Egan. Once production has begun, neither standard or custom orders are eligible for change or cancellation.

Change Orders

The Egan Visual 'Order Acknowledgment' is final and binding and any subsequent change is subject to approval at the sole discretion of Egan. Egan Visual reserves the right to increase the acknowledged price, if such a change warrants any extra charge.

Defects and Shortages

All claims must be reported within the first **TEN (10) days** after delivery of goods. Egan Visual assumes no responsibility for misuse or abuse.

Returns

Merchandise may not be returned without the prior written consent of Egan Visual. If returned within thirty (30) days, and by agreement, a restocking and repacking charge will be deducted from the credit note in addition to any expense for reconditioning that may be necessary. Return transportation must be prepaid (DDP Buffalo, NY or DDP Vaughan, ON), packed in the original packaging.

Financial Terms

Financial Terms

Terms are "prepayment with order" unless otherwise pre-approved, in writing, in advance, by Egan Visual. For such accounts, orders are subject to limit or withdrawal of credit at any time. The approved purchaser will be invoiced for the goods as they are shipped and payment is due thirty (30) days from the date of invoice. Late penalties will be charged on overdue invoices. Invoices are payable in USD funds and do not include taxes or installation. All orders accepted are subject to prices prevailing at time of Order Acknowledgment.

Quotations

Quotes issued by Egan Visual are valid for ninety (90) days and are for the products and terms specified therein.

Order Acceptance

Orders are binding only upon acceptance by the executive office of Egan Visual which is confirmed by issuance of an Egan Order Acknowledgment. Orders accepted by Egan Visual shall be subject to the Terms and Conditions set forth in this Acknowledgment and subsequent Invoice, notwithstanding any variance in terms and conditions set forth in the buyer's order forms. Minimum order value is \$100.00 list. Egan Visual appreciates your order and will endeavor to fulfill it as agreed.

Taxes

Sales Tax, Use Tax, or other State, Provincial, or Federal taxes will be added to the invoice as applicable, and are the responsibility of the Buyer. Buyers claiming exemption (e.g. purchasing for resale) must supply the appropriate tax exemption form with their order. In jurisdictions where Egan Visual is not registered to collect tax, it is the sole responsibility of the Buyer to determine what, if any tax is applicable to the sale and to remit same to the appropriate tax authority.

Product Terms

Specification Changes

Specifications published are nominal and believed to be accurate at the time of publication. The right to affect, change, or discontinue models at any time without prior notice remains the right of Egan Visual. This right to change applies to catalog contents, price lists, fabric or finishes, as well as details and dimensions.

Warranty

Each product carries a limited, "Return to Factory" warranty. See the full "Standard Warranty" in the Price & Specification Guide or at www.egan.com

Logistics Terms

Freight Terms

Orders are shipped FOB Factory (INCOTERMS 2010). Freight is prepaid and added to the buyer's Invoice. The responsibility of Egan Visual ceases when it turns the shipment over to the carrier.

Free Freight Program

Egan offers a program under which freight may be prepaid in full or subsidized by Egan. See "Freight Program" for current details.

Drop Shipments

Drop Shipments can be arranged. Egan does not apply a fee but Accessorial Charges may apply. Contact Customer Service.

Accessorial Charges

Accessorial Charges will be invoiced at cost and pre-quoted on request. This includes but is not limited to: deliver to limited access site (mines, prisons, military, schools, and hospitals), blanket wrapped, inside deliveries, special charges for high density urban areas, will calls, 'call before' requirements and special delivery or inside delivery beyond dock-to-dock delivery

Packing and Crating Charges

All products are shipped via common carrier, and are normally shipped one unit per cardboard container. Packaging charges are included in the price.

Carrier Selection

In absence of the buyer arranging transport, Egan Visual reserves the right to ship by what is in its opinion the best method.

Transportation Delay

Egan Visual is not responsible for delay or failure to fulfill an order due to Acts of God, Hardship, or Force Majeure, including but not limited to reasons stated in the standard ICC Force Majeure Clause section 3.

Storage

If Buyer cannot accept delivery on the shipping date stated on the Order Acknowledgment, Egan Visual reserves the right to arrange storage at the Buyer's risk and expense.

Freight Damage

All goods are shipped FOB Egan Visual, however, in the event of freight damage we can assist your receiver with the claim. The legal responsibility of Egan Visual ceases when it turns the shipment over to a common carrier. The buyer has the sole obligation of seeking recourse against the carrier. All freight is given to the carrier and signed for in good condition. It is the responsibility of the receiver to sign for the goods in the presence of the carrier and note the condition in which they are received. Freight claims should be filed with the carrier.

Follow these procedures immediately upon receipt of shipment:

1. You must inspect the freight at the time of delivery and note all damages on the Bill of Lading and Delivery Receipt (POD). If there is obvious and severe damage, receiver has a **right to refuse delivery**. Receiver also has a duty to mitigate the loss. For example, you should only refuse affected product.
2. Upon discovery of the damages, the receiver must immediately report the damages to the carrier, asking for immediate inspection and an inspection report.
3. The notification of damages must be followed up in writing by fax or e-mail.
4. Unpack and inspect. Check your contents within **THREE (3) business days**. If the shipment was delivered without noted damage but has CONCEALED DAMAGE, receiver typically has a very limited time to report it to the carrier and request a 'concealed damage inspection'.
5. Tag and keep any packaging in which damaged goods are received in its original condition.
6. Contact Egan Customer Service to initiate a Support Case and make arrangements for replacement product.

Freight Program & Egan Standard Warranty



Freight Program

Egan is please to offer a Freight Program that allows customers to enjoy most shipments to arrive free of freight charges! Based on the **order total** summed using the **list price** of the products, the freight costs are invoiced per the following table:

Single shipment total at LIST	Freight Charge*	Single shipment total at LIST	Freight Charge*
\$0 - \$1499	\$199	\$2000 - \$2999	\$99
\$1500 - \$1999	\$129	\$3000+	Nil (\$0)

*amount added to invoice
*excluding Accessorial charges, per Standard Terms

Egan Standard Warranty

What is Covered

This Standard Warranty applies to new products purchased from an authorized Egan Visual ("Egan") dealer or reseller. Egan Visual warrants that the products substantially conform to the specifications published by Egan at the time of manufacture of the product, and that the product is free from material defects in materials and workmanship, under normal and reasonable operating conditions, for the Warranty Term as defined below. No other warranties or representations, express or implied, other than contained herein shall apply or be honored by Egan Visual.

Who is Covered

The "End User" holds this Standard Warranty. The End User is the first party to purchase the new and unused product from an authorized Egan reseller. This Standard Warranty is not transferable to other parties.

What is Not Covered

EGAN VISUAL MAKES NO IMPLIED WARRANTIES OF FITNESS FOR A PARTICULAR PURPOSE. THESE AND ALL OTHER IMPLIED WARRANTIES ARE SPECIFICALLY DISCLAIMED BY EGAN VISUAL. The warranty as stated in this document is the complete and only warranty upon this product. This Warranty specifically excludes:

- Products that are not purchased by the End User from an authorized reseller
- Products that have been used other than according to the instructions
- Products that have been damaged due to the connection of other equipment
- Products that have not been installed and or/maintained as per the instructions
- Products that have been damaged
- Products that have been modified
- Peripheral products in the package such as brackets and fittings, which are "as is"
- Products and services that are not provided by Egan, including installation, de-installation, and shipping
- Variations in surface materials (e.g. grains, patterns, textures), color variation and colorfastness
- Non Egan-branded products or components which may be purchased from Egan, which are subject to that manufacturer's own warranty.

IMPORTANT: READ AND UNDERSTAND ALL INSTALLATION, USE, AND MAINTENANCE INSTRUCTIONS THAT YOU HAVE RECEIVED WITH YOUR NEW EGAN VISUAL PRODUCT. Failure to do so will void all warranty. Before attempting to deviate from our instructions in any way please contact Egan Visual beforehand. If in doubt as to how to install any of our products please contact the Egan Visual dealer you purchased the product from or contact our Customer Service department immediately for help.

Installation is not covered. Egan Visual products are designed to be installation-ready, however Installation and the installation environment are out of the control of Egan and therefore installation is not warranted by Egan in any circumstance. Egan offers dealers and professional installers free installation support via **1-800-263-2387**.

Conditions after leaving our facility are always beyond the control of Egan Visual. As noted above, **damage is not covered.** This includes but is not limited to damage from use of non-approved detergents, abrasives or other harsh cleaning agents, poor installation, misuse, abuse, neglect, or failure to maintain the product properly. Always be sure to test a cleaning product in an inconspicuous area before cleaning any surface, coating, or finish. For best results on presentation surfaces, always use quality alcohol-based markers; Egan-supplied markers and cloths are recommended. If marker suitability is in question, please call our Customer Service before using the product for the first time. This warranty does not cover damage to writing surface resulting from negligence, abuse or accidents, such as burns, cuts, scratches, scuffs, kinks, or indentations.

Limitations and exclusions

This program is limited to destinations in the 48 contiguous States, and 10 Canadian Provinces (excludes the Territories YT, NT, NU). This program provides for normal ground transportation. Program eligibility is subject to Egan Standard Terms & Conditions.

Warranty Term

Your new Egan Visual product has been well-designed and built for many years of enjoyment. All Egan Visual products carry a warranty term of five (5) years from the date of purchase unless otherwise stated here:

EVS® Presentation Surfaces "Guaranteed-to-Clean"	10 years
Porcelain surfaces	10 years
GlassWrite™ and EganAero™ surfaces	10 years
VersaPalette™ products	30 days
EganINK™ (ASTM F793 10a Category I Wallcovering)	1 year
Electric-powered mechanisms	1 year
Electric components (e.g. wiring, charging ports, outlets)	1 year
Lighting components	1 year
Monitor including back light.	90 day
Supplies	None
Installation	None

Extended Warranty Term

An extended warranty term may be available for purchase. Please call to inquire.

Consequential or Incidental Damages

EGAN VISUAL WILL NOT BE LIABLE FOR CONSEQUENTIAL OR INCIDENTAL DAMAGES. Any loss, expense, or damage incurred in replacing any suspected defective Egan Visual product will not be reimbursed. The warranty of this product is limited to the replacement or repair of the Egan Visual product itself. Under no circumstances will Egan Visual be responsible for incidental damages, repairs, labor or other costs incurred in removal or return of suspected defective Egan Visual product.

How to make a Warranty Claim

While the product is still in its original installed state, contact Customer Service to open a case for your product and to have the claim evaluated. If a written Return Authorization has been issued by Egan Visual, the product may be uninstalled and shipped. Shipments that arrive without a valid Return Authorization will not be accepted.

Warranty Point

This warranty is a "Return to Factory" or "RTF" Warranty. To exercise this warranty, the product must be shipped to Egan DDP Buffalo, NY (INCOTERMS 2010) or DDP Vaughan, ON (INCOTERMS 2010) at the discretion of Egan Visual. Replacement product is made available FOB Buffalo, NY or EXW Vaughan, ON.

Processing of a Warranty Claim

Your product will be evaluated within a reasonable period of time and at the sole option of Egan Visual and if the claim is approved by Egan it will be repaired, or replaced with refurbished or new product. In the event that the model has been discontinued and warranty stocks have been depleted, Egan, may, at its sole option, replace the Product with a different model with comparable or better performance characteristics. At the sole option of Egan Visual, if repair or replacement is not practicable, Egan will provide a refund or a credit for the affected product.

EGAN

Egan Visual

1-800-263-2387

customerservice@egan.com

Mon-Fri: 8:00am - 6:00pm ET

www.egan.com

BUILT

TO INSPIRE

July 13, 2021 - Printed in Canada. © Egan Visual 2021. All Rights Reserved. All other product names are trademarks of their respective owners. Samples available from Egan Customer Service. Specifications are subject to change without notice. E&OE.